

SPEED CONTROL MOTOR - SU SERIES

120W

□90mm

INDUCTION MOTOR

K9IS120F□-SU

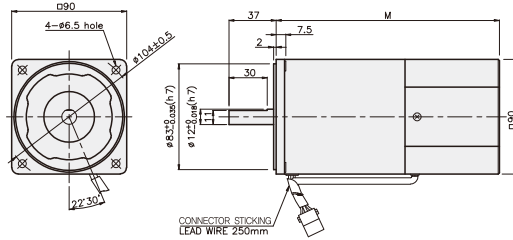

DIMENSION TABLE

PART No	M	Application Model
K9IS120F□-SU-C50	195	50Hz
K9IS120F□-SU	175	60Hz

※ 50Hz motor is "C50" added to model number.

SPECIFICATIONS

120W continuous rating, four poles

Model	Voltage (V)	Frequency (Hz)	Speed (rpm)	Permissible Torque		Start T. (N·m/kgf·cm)	Current (A)	Condenser (μF)
				1200 rpm (N·m/kgf·cm)	90 rpm (N·m/kgf·cm)			
K9I□120FJ-SU-C50	100	50	90 ~ 1400	0.83/8.3	0.3/3	0.4/4	3.4	35
K9I□120FJ-SU			90 ~ 1700					
K9I□120FU-SU	110	60	90 ~ 1700	0.83/8.3	0.3/3	0.45/4.5	3.2	30
K9I□120FL-SU-C50	200	50	90 ~ 1400	0.83/8.3	0.28/2.8	0.4/4	1.4	8.5
K9I□120FL-SU			90 ~ 1700					
K9I□120FC-SU-C50	220	50	90 ~ 1400	0.83/8.3	0.28/2.8	0.4/4	1.2	6
			90 ~ 1700					
K9I□120FC-SU	220	60	90 ~ 1400	0.8/8	0.3/3	0.45/4.5	1.4	7
			90 ~ 1700					
K9I□120FD-SU-C50	240	50	90 ~ 1400	0.83/8.3	0.28/2.8	0.4/4	1.3	6

* □ : SHAFT SHAPE (S : STRAIGHT, P : PINION)

RATED TORQUE OF GEARHEAD

● Single-phase 100V/115V

unit = above : N·m / below : Kgf·cm

Model	Ratio	3	3.6	5	6	7.5	9	10	12.5	15	18	20	25	30	36	40	50	60	75	90	100	120	150	180	200
Motor/Gearhead	Speed(rpm)																								
K9I□120F□-SU K9P□B, BF	1200	2.02 20.2	2.42 24.2	3.36 33.6	4.03 40.3	5.04 50.4	6.05 60.5	6.72 67.2	7.56 75.6	9.08 90.8	10.89 108.9	12.10 121.0	13.61 136.1	16.34 163.4	19.60 196.0	20	20	20	20	20	20	20	20	20	20
	90	0.73 7.3	0.87 8.7	1.22 12.2	1.46 14.6	1.82 18.2	2.19 21.9	2.43 24.3	2.73 27.3	3.28 32.8	3.94 39.4	4.37 43.7	4.92 49.2	5.90 59.0	7.09 70.9	7.87 78.7	9.84 98.4	11.81 118.1	13.29 132.9	15.94 159.4	17.71 177.1	20	20	20	20

● Single-phase 200V/240V

unit = above : N·m / below : Kgf·cm

Model	Ratio	3	3.6	5	6	7.5	9	10	12.5	15	18	20	25	30	36	40	50	60	75	90	100	120	150	180	200
Motor/Gearhead	Speed(rpm)																								
K9I□120F□-SU K9P□B, BF	1200	200V/220V/230V 240V/50Hz	2.02 20.2	2.42 24.2	3.36 33.6	4.03 40.3	5.04 50.4	6.05 60.5	6.72 67.2	7.56 75.6	9.08 90.8	10.89 108.9	12.10 121.0	13.61 136.1	16.34 163.4	19.60 196.0	20	20	20	20	20	20	20	20	20
		200V/220V 230V/60Hz	1.94 19.4	2.33 23.3	3.24 32.4	3.89 38.9	4.86 48.6	5.83 58.3	6.48 64.8	7.29 72.9	8.75 87.5	10.50 105.0	11.66 116.6	13.12 131.2	15.75 157.5	18.90 189.0	20	20	20	20	20	20	20	20	20
	90	200V/220V/230V 240V/50Hz	0.68 6.8	0.82 8.2	1.13 11.3	1.36 13.6	1.70 17.0	2.04 20.4	2.27 22.7	2.55 25.5	3.06 30.6	3.67 36.7	4.08 40.8	4.59 45.9	5.51 55.1	6.61 66.1	7.35 73.5	9.19 91.9	11.02 110.2	12.40 124.0	14.88 148.8	16.53 165.3	19.84 198.4	20	20
		200V/220V 230V/50Hz	0.73 7.3	0.87 8.7	1.22 12.2	1.46 14.6	1.82 18.2	2.19 21.9	2.43 24.3	2.73 27.3	3.28 32.8	3.94 39.4	4.37 43.7	4.92 49.2	5.90 59.0	7.09 70.9	7.87 78.7	9.84 98.4	11.81 118.1	13.29 132.9	15.94 159.4	17.71 177.1	20	20	20

- * Gearhead and decimal gearhead are sold separately.
- * The code in □ of gearhead model is for gear ratio.
- * color indicates that the output shaft of the geared motor rotates in the same direction as the output shaft of the motor. Others indicate rotation in the opposite direction.
- * If you are to have less ratio than the ratio in the table, you can install the decimal gearhead, which has one tenth of the ratio, between the gearhead and the motor. In this case, the permissible torque is 20N·m/200kgf·cm.
- * RPM is based on motor's synchronous rpm (50Hz:1500rpm, 60Hz:1800rpm) and calculated by dividing gear ratio. Actual rpm is 2~20% less than indicating rpm according to load size.

SPEED CONTROL MOTOR - SU SERIES

GEARHEADS

RATED TORQUE OF GEARHEAD

● Single-phase 100V/115V

unit = above : N·m / below : Kgf·cm

Model	Ratio																									
		3	3,6	5	6	7,5	9	10	12,5	15	18	20	25	30	36	40	50	60	75	90	100	120	150	180	200	
K9I□120F□-SU K9P□BU, BUF	1200	2.02 20,2	2.42 24,2	3.36 33,6	4.03 40,3	5.04 50,4	6.05 60,5	6.72 67,2	7.56 75,6	9.08 90,8	10.89 108,9	12.10 121,0	13.61 136,1	16.34 163,4	19.60 196,0	21.78 217,8	27.23 272,3	30 300	30 300	30 300	30 300	30 300	30 300	30 300	30 300	30 300
	90	0.73 7,3	0.87 8,7	1.22 12,2	1.46 14,6	1.82 18,2	2.19 21,9	2.43 24,3	2.73 27,3	3.28 32,8	3.94 39,4	4.37 43,7	4.92 49,2	5.90 59,0	7.09 70,9	7.87 78,7	9.84 98,4	11.81 118,1	13.29 132,9	15.94 159,4	17.71 177,1	21.26 212,6	26.57 265,7	30 300	30 300	30 300

● Single-phase 200V/240V

unit = above : N·m / below : Kgf·cm

Model	Ratio																									
		3	3,6	5	6	7,5	9	10	12,5	15	18	20	25	30	36	40	50	60	75	90	100	120	150	180	200	
K9I□120F□-SU K9P□BU, BUF	1200	200V/220V/230V 240V/50HZ	2.02 20,2	2.42 24,2	3.36 33,6	4.03 40,3	5.04 50,4	6.05 60,5	6.72 67,2	7.56 75,6	9.08 90,8	10.89 108,9	12.10 121,0	13.61 136,1	16.34 163,4	19.60 196,0	21.78 217,8	27.23 272,3	30 300	30 300	30 300	30 300	30 300	30 300	30 300	30 300
		200V/220V 230V/60HZ	1.94 19,4	2.33 23,3	3.24 32,4	3.89 38,9	4.86 48,6	5.83 58,3	6.48 64,8	7.29 72,9	8.75 87,5	10.50 105,0	11.66 116,6	13.12 131,2	15.75 157,5	18.90 189,0	21.00 210,0	26.24 262,4	30 300	30 300	30 300	30 300	30 300	30 300	30 300	30 300
	90	200V/220V/230V 240V/50HZ	0.68 6,8	0.82 8,2	1.13 11,3	1.36 13,6	1.70 17,0	2.04 20,4	2.27 22,7	2.55 25,5	3.06 30,6	3.67 36,7	4.08 40,8	4.59 45,9	5.51 55,1	6.61 66,1	7.35 73,5	9.19 91,9	11.02 110,2	12.40 124,0	14.88 148,8	16.53 165,3	19.84 198,4	24.80 248,0	29.76 297,6	30 300
		200V/220V 230V/60HZ	0.73 7,3	0.87 8,7	1.22 12,2	1.46 14,6	1.82 18,2	2.19 21,9	2.43 24,3	2.73 27,3	3.28 32,8	3.94 39,4	4.37 43,7	4.92 49,2	5.90 59,0	7.09 70,9	7.87 78,7	9.84 98,4	11.81 118,1	13.29 132,9	15.94 159,4	17.71 177,1	21.26 212,6	26.57 265,7	30 300	30 300

- * Gearhead and decimal gearhead are sold separately.
- * The code in □ of gearhead model is for gear ratio.
- * color indicates that the output shaft of the geared motor rotates in the same direction as the output shaft of the motor. Others indicate rotation in the opposite direction.
- * If you are to have less ratio than the ratio in the table, you can install the decimal gearhead, which has one tenth of the ratio, between the gearhead and the motor. In this case, the permissible torque is 30N·m/300kgf·cm.
- * RPM is based on motor's synchronous rpm (50HZ:1500rpm, 60HZ:1800rpm) and calculated by dividing gear ratio. Actual rpm is 2~20% less than indicating rpm according to load size.

CONNECTION DIAGRAMS

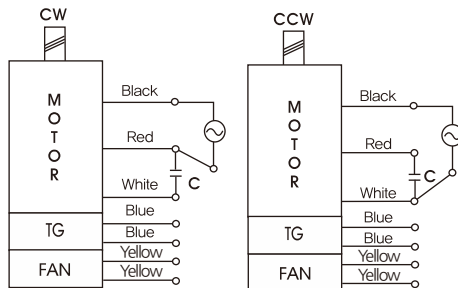

※The direction of motor rotation is as viewed from the front shaft end of the motor

GEARHEADS

DIMENSIONS

K9P□B



K9P□BF, BUF



K9P□BU

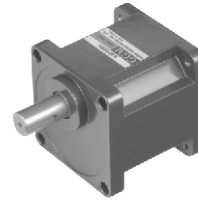

DECIMAL GEARHEAD

K9P10BX

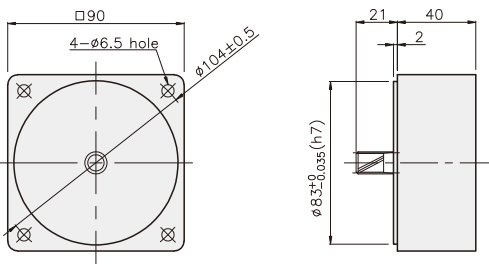

KEYSPEC

● KEY

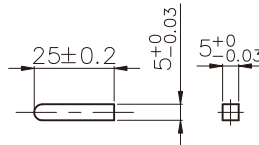

● KEY GROOVE

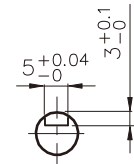

GEARHEAD

K9P□B

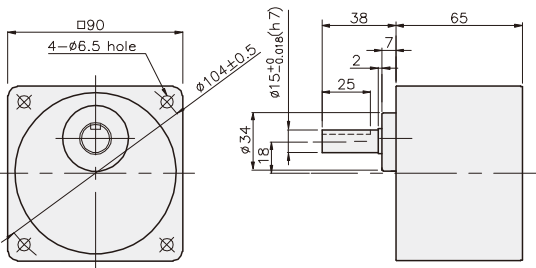

K9P□BF

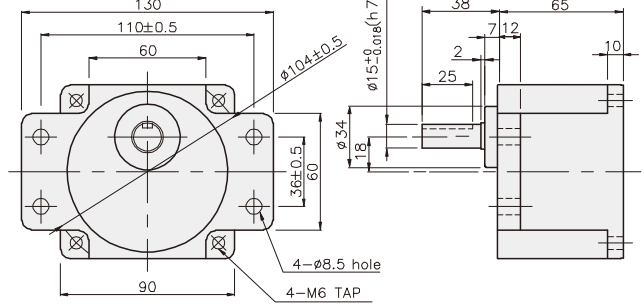

K9P□BU

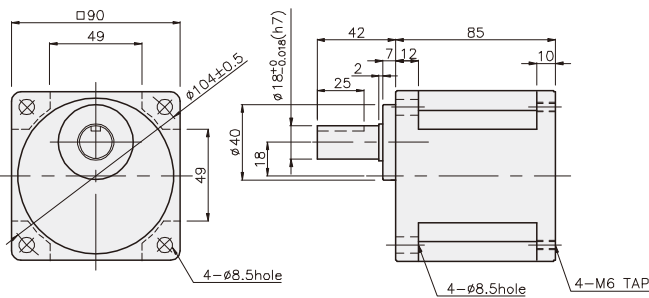

K9P□BUF

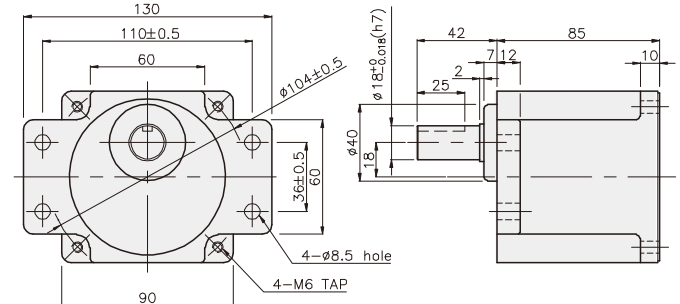

GEARHEADS

DIMENSIONS

K9IP120F□-SU + K9P□B



K9IP120F□-SU + K9P□BF, BUF



K9IP120F□-SU + K9P□BU



K9IP120F□-SU + K9P□B

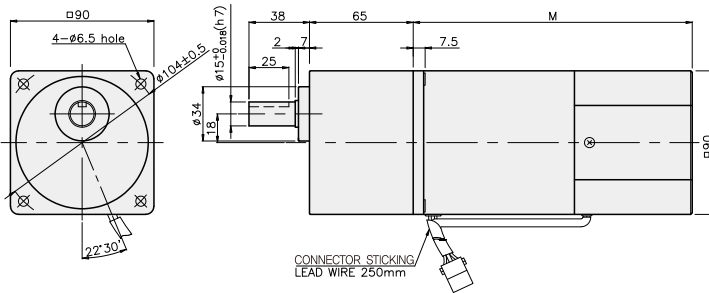

WEIGHT

PART	WEIGHT(kg)
MOTOR	3,54
DECIMAL GEAR HEAD	0,62

DIMENSION TABLE

PART No.	M	Application Model
01	195	50Hz
02	175	60Hz

DIMENSION TABLE

PART No.	L	Application Model	Mounting BOLT
01	65	K9P3~200B	M6 P1,0 X 95
02	40	K9P10BX	M6 P1,0 X 140

K9IP120F□-SU + K9P□BF

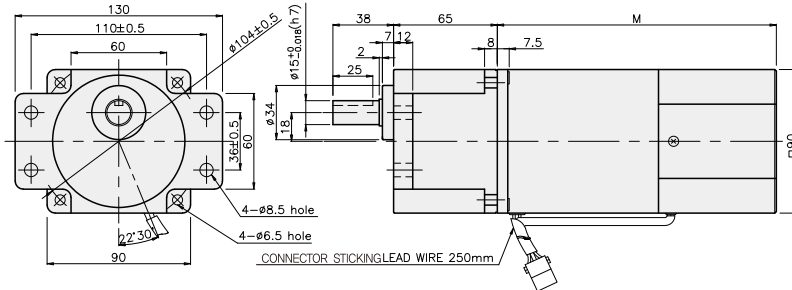

WEIGHT

PART	WEIGHT(kg)
K9P3~10B	1,22
K9P12,5~20B	1,32
K9P25~60B	1,42
K9P75~200B	1,45

DIMENSION TABLE

PART No.	L	Application Model	Mounting BOLT
01	65	K9P3~200BF	M6 P1,0 X 25
02	40	K9P10BX	M6 P1,0 X 65

K9IP120F□-SU + K9P□BU

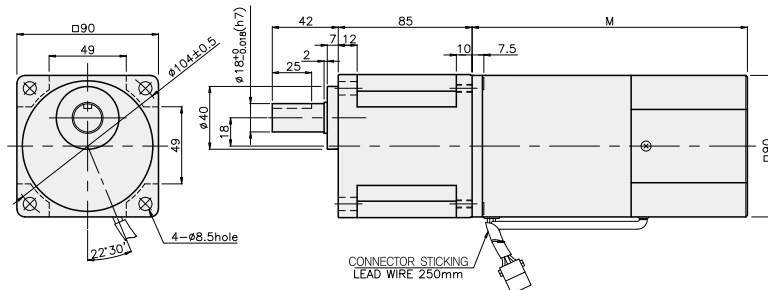

WEIGHT

PART	WEIGHT(kg)
K9P3~10BF	1,22
K9P12,5~20BF	1,30
K9P25~60BF	1,42
K9P75~200BF	1,44

DIMENSION TABLE

PART No.	L	Application Model	Mounting BOLT
01	85	K9P3~200BU	M6 P1,0 X 20
02	40	K9P10BX	M6 P1,0 X 60

WEIGHT

PART	WEIGHT(kg)
K9P3~10BU	1,44
K9P12,5~20BU	1,55
K9P25~60BU	1,69
K9P75~200BU	1,74

K9IP120F□-SU + K9P□BUF

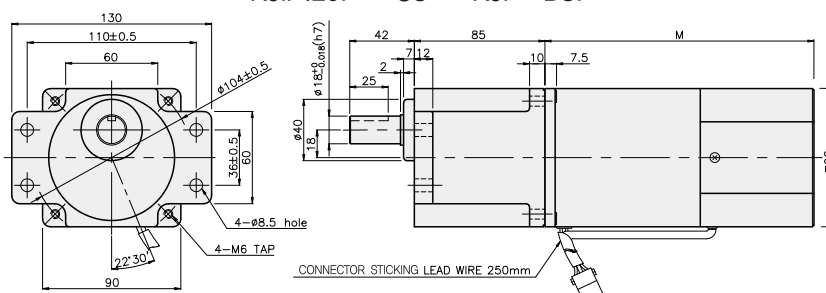

DIMENSION TABLE

PART No.	L	Application Model	Mounting BOLT
01	85	K9P3~200BUF	M6 P1,0 X 20
02	40	K9P10BX	M6 P1,0 X 65

WEIGHT

PART	WEIGHT(kg)
K9P3~10BUF	1,50
K9P12,5~20BUF	1,62
K9P25~60BUF	1,76
K9P75~200BUF	1,82