

SPEED CONTROL MOTOR - SU SERIES

120W

□90mm

REVERSIBLE MOTOR

K9RS120F□-SU

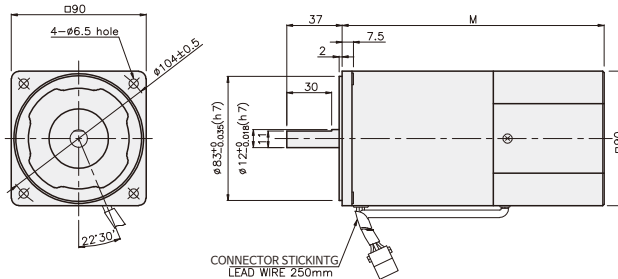

DIMENSION TABLE

PART No	M	Application Model
K9RS120F□-SU-C50	195	50Hz
K9RS120F□-SU	175	60Hz

※ 50Hz motor is "C50" added to model number.

SPECIFICATIONS

120W 30 minutes rating, four poles

Model	Maximum Out Put (w)	Voltage (V)	Frequency (Hz)	Speed Range (rpm)	Permissible Torque		Start T. (N·m/kgf·cm)	Current (A)	Condenser (μF)
					1200rpm	90rpm			
					(N·m/kgf·cm)	(N·m/kgf·cm)			
K9R□120FJ-SU-C50	120	100	50	90~1400	0.85/8.5	0.31/3.1	0.45/4.5	3.6	40
K9R□120FJ-SU			60	90~1700					
K9R□120FU-SU	120	110	60	90~1700	0.8/8	0.28/2.8	0.4/4	3	25
		115							
K9R□120FL-SU-C50	200	200	50	90~1400	0.8/8	0.27/2.7	0.37/3.7	1.4	8.5
K9R□120FL-SU			60	90~1700					
K9R□120FC-SU-C50	120	220	50	90~1400	0.8/8	0.27/2.7	0.37/3.7	1.2	6
		230		90~1700					
K9R□120FC-SU	120	220	60	90~1400	0.78/7.8	0.29/2.9	0.42/4.2	1.4	7
		230		90~1700					
K9R□120FD-SU-C50	120	240	50	90~1400	0.8/8	0.27/2.7	0.37/3.7	1.3	6

* □ : SHAFT SHAPE (S : STRAIGHT, P : PINION)

RATED TORQUE OF GEARHEAD

● Single-phase 100V/115V

unit = above : N·m / below : kgf·cm

Motor/Gearhead	Ratio	Speed(rpm)	Ratio																								
			3	3.6	5	6	7.5	9	10	12.5	15	18	20	25	30	36	40	50	60	75	90	100	120	150	180	200	
K9R□120F□-SU K9P□B, BF	1200	100V/50/60Hz	2.07	2.48	3.44	4.13	5.16	6.20	6.89	7.75	9.29	11.15	12.39	13.94	16.73	20	20	20	20	20	20	20	20	20	20	20	20
		110V/115V/60Hz	1.94	2.33	3.24	3.89	4.86	5.83	6.48	7.29	8.75	10.50	11.66	13.12	15.75	18.90	20	20	20	20	20	20	20	20	20	20	20
	90	100V/50/60Hz	0.75	0.90	1.26	1.51	1.88	2.26	2.51	2.82	3.39	4.07	4.52	5.08	6.10	7.32	8.14	10.17	12.20	13.73	16.47	18.31	20	20	20	20	20
		110V/115V/60Hz	0.68	0.82	1.13	1.36	1.70	2.04	2.27	2.55	3.06	3.67	4.08	4.59	5.51	6.61	7.35	9.19	11.02	12.40	14.88	16.53	19.84	20	20	20	20

- * Gearhead and decimal gearhead are sold separately.
- * The code in □ of gearhead model is for gear ratio.
- * color indicates that the output shaft of the geared motor rotates in the same direction as the output shaft of the motor, Others indicate rotation in the opposite direction.
- * If you are to have less ratio than the ratio in the table, you can install the decimal gearhead, which has one tenth of the ratio, between the gearhead and the motor. In this case, the permissible torque is 3N·m/30kgf·cm.
- * RPM is based on motor's synchronous rpm (50HZ:1500rpm, 60HZ:1800rpm) and calculated by dividing gear ratio. Actual rpm is 2~20% less than indicating rpm according to load size.

GEARHEAD

RATED TORQUE OF GEARHEAD

● Single-phase 200V/240V

unit = above : N·m / below : kgf·cm

Model Motor/Gearhead	Ratio Speed(rpm)	3	3.6	5	6	7.5	9	10	12.5	15	18	20	25	30	36	40	50	60	75	90	100	120	150	180	200	
		K9R□120F□-SU K9P□B, BF	1200	200V/220V/ 230V/240V 50Hz	1.94 19.4	2.33 23.3	3.24 32.4	3.89 38.9	4.86 48.6	5.38 53.8	6.48 64.8	7.29 72.9	8.75 87.5	10.50 105.0	11.66 116.6	13.12 131.2	15.75 157.5	18.90 189.0	20	20	20	20	20	20	20	20
200V/220V/ 230V 60Hz	1.90 19.0			2.27 22.7	3.16 31.6	3.79 37.9	4.74 47.4	5.69 56.9	6.32 63.2	7.11 71.1	8.53 85.3	10.24 102.4	11.37 113.7	12.79 127.9	15.35 153.5	18.42 184.2	20	20	20	20	20	20	20	20	20	20
90	200V/220V/ 230V/240V 50Hz		0.66 6.6	0.79 7.9	1.09 10.9	1.31 13.1	1.64 16.4	1.97 19.7	2.19 21.9	2.46 24.6	2.95 29.5	3.54 35.4	3.94 39.4	4.43 44.3	5.31 53.1	6.38 63.8	7.09 70.9	8.86 88.6	10.63 106.3	11.96 119.6	14.35 143.5	15.94 159.4	19.13 191.3	20	20	20
	200V/220V/ 230V 60Hz		0.70 7.0	0.85 8.5	1.17 11.7	1.41 14.1	1.76 17.6	2.11 21.1	2.35 23.5	2.64 26.4	3.17 31.7	3.81 38.1	4.23 42.3	4.76 47.6	5.71 57.1	6.85 68.5	7.61 76.1	9.51 95.1	11.42 114.2	12.84 128.4	15.41 154.1	17.12 171.2	20	20	20	20

● Single-phase 100V/115V

unit = above : N·m / below : kgf·cm

Model Motor/Gearhead	Ratio Speed(rpm)	3	3.6	5	6	7.5	9	10	12.5	15	18	20	25	30	36	40	50	60	75	90	100	120	150	180	200	
		K9R□120F□-SU K9P□BU, BUF	1200	100V 50/60Hz	2.07 20.7	2.48 24.8	3.44 34.4	4.13 41.3	5.16 51.6	6.20 62.0	6.89 68.9	7.75 77.5	9.29 92.9	11.15 111.5	12.39 123.9	13.94 139.4	16.73 167.3	20.08 201	22.31 223	27.88 279	30	30	30	30	30	30
110V/115V 60Hz	1.94 19.4			2.33 23.3	3.24 32.4	3.89 38.9	4.86 48.6	5.83 58.3	6.48 64.8	7.29 72.9	8.75 87.5	10.50 105.0	11.66 116.6	13.12 131.2	15.75 157.5	18.90 189.0	21.00 210	26.24 262	30	30	30	30	30	30	30	30
90	100V 50/60Hz		0.75 7.5	0.90 9.0	1.26 12.6	1.51 15.1	1.88 18.8	2.26 22.6	2.51 25.1	2.82 28.2	3.39 33.9	4.07 40.7	4.52 45.2	5.08 50.8	6.10 61.0	7.32 73.2	8.14 81.4	10.17 101.7	12.20 122.0	13.73 137.3	16.47 164.7	18.31 183.1	21.97 219.7	27.46 274.6	30	30
	110V/115V 60Hz		0.68 6.8	0.82 8.2	1.13 11.3	1.36 13.6	1.70 17.0	2.04 20.4	2.27 22.7	2.55 25.5	3.06 30.6	3.67 36.7	4.08 40.8	4.59 45.9	5.51 55.1	6.61 66.1	7.35 73.5	9.19 91.9	11.02 110.2	12.40 124.0	14.88 148.8	16.53 165.3	19.84 198.4	24.80 248.0	29.76 297.6	30

● Single-phase 200V/240V

unit = above : N·m / below : kgf·cm

Model Motor/Gearhead	Ratio Speed(rpm)	3	3.6	5	6	7.5	9	10	12.5	15	18	20	25	30	36	40	50	60	75	90	100	120	150	180	200	
		K9R□120F□-SU K9P□BU, BUF	1200	200V/220V/ 230V/240V 50Hz	1.94 19.4	2.33 23.3	3.24 32.4	3.89 38.9	4.86 48.6	5.83 58.3	6.48 64.8	7.29 72.9	8.75 87.5	10.50 105.0	11.66 116.6	13.12 131.2	15.75 157.5	18.90 189.0	21.00 210.0	26.24 262.4	30	30	30	30	30	30
200V/220V/ 230V/60Hz	1.90 19.0			2.27 22.7	3.16 31.6	3.79 37.9	4.74 47.4	5.69 56.9	6.32 63.2	7.11 71.1	8.53 85.3	10.24 102.4	11.37 113.7	12.79 127.9	15.35 153.5	18.42 184.2	20.47 204.7	25.59 255.9	30	30	30	30	30	30	30	30
90	200V/220V/ 230V/240V 50Hz		0.66 6.6	0.79 7.9	1.09 10.9	1.31 13.1	1.64 16.4	1.97 19.7	2.19 21.9	2.46 24.6	2.95 29.5	3.54 35.4	3.94 39.4	4.43 44.3	5.31 53.1	6.38 63.8	7.09 70.9	8.86 88.6	10.63 106.3	11.96 119.6	14.35 143.5	15.94 159.4	19.13 191.3	23.91 239.1	28.70 287.0	30
	200V/220V/ 230V/60Hz		0.70 7.0	0.85 8.5	1.17 11.7	1.41 14.1	1.76 17.6	2.11 21.1	2.35 23.5	2.64 26.4	3.17 31.7	3.81 38.1	4.23 42.3	4.76 47.6	5.71 57.1	6.85 68.5	7.61 76.1	9.51 95.1	11.42 114.2	12.84 128.4	15.41 154.1	17.12 171.2	20.55 205.5	25.69 256.9	30	30

- * Gearhead and decimal gearhead are sold separately.
- * The code in □ of gearhead model is for gear ratio.
- * color indicates that the output shaft of the geared motor rotates in the same direction as the output shaft of the motor. Others indicate rotation in the opposite direction.
- * If you are to have less ratio than the ratio in the table, you can install the decimal gearhead, which has one tenth of the ratio, between the gearhead and the motor. In this case, the permissible torque is 3N·m/30kgf·cm.
- * RPM is based on motor's synchronous rpm (50HZ:1500rpm, 60HZ:1800rpm) and calculated by dividing gear ratio. Actual rpm is 2~20% less than indicating rpm according to load size.

CONNECTION DIAGRAMS

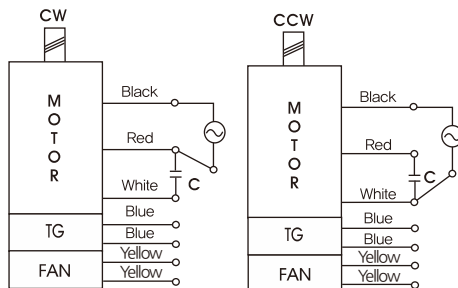

※The direction of motor rotation is as viewed from the front shaft end of the motor

GEARHEAD

DIMENSIONS

K9P□B



K9P□BF, BUF



K9P□BU

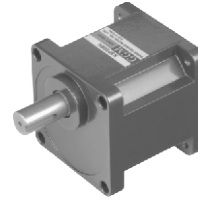

DECIMAL GEARHEAD

K9P10BX

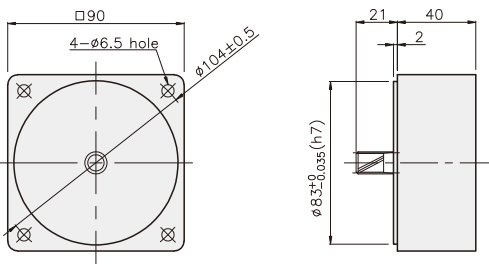

KEYSPEC

● KEY

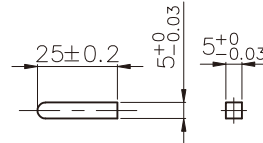

● KEY GROOVE

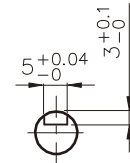

GEARHEAD

K9P□B

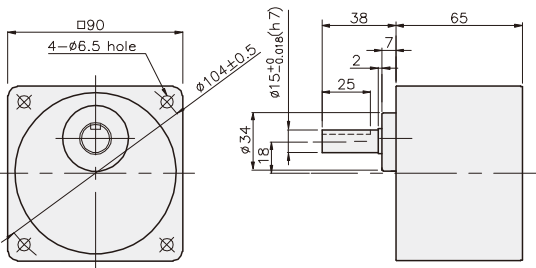

K9P□BF

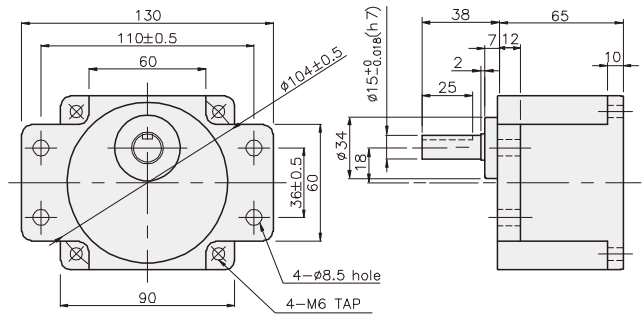

K9P□BU

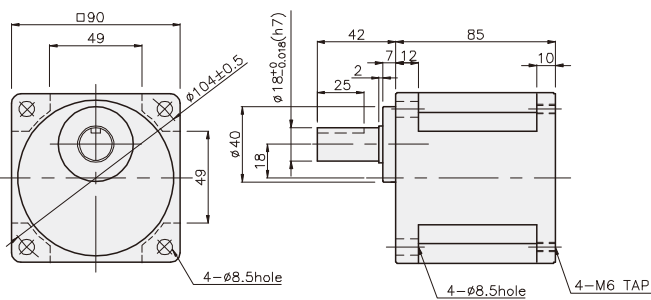

K9P□BUF

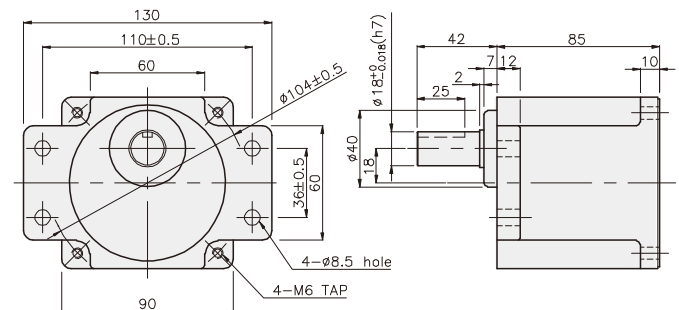

GEARHEAD

DIMENSIONS

K9RP120F□-SU + K9P□B



K9RP120F□-SU + K9P□BF, BUF



K9RP120F□-SU + K9P□BU



K9RP120F□-SU + K9P□B

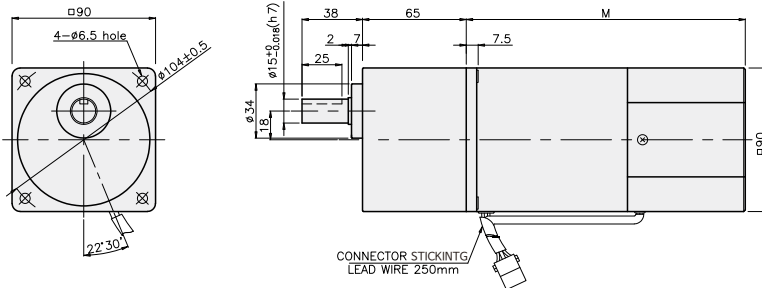

K9RP120F□-SU + K9P□BF

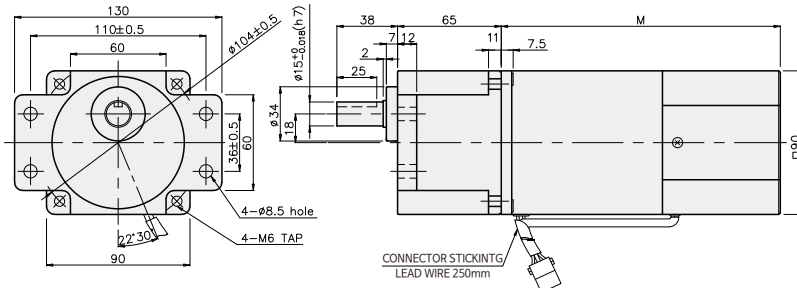

K9RP120F□-SU + K9P□BU

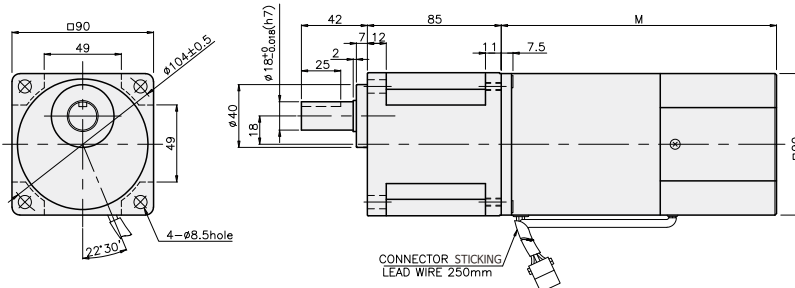

K9RP120F□-SU + K9P□BUF

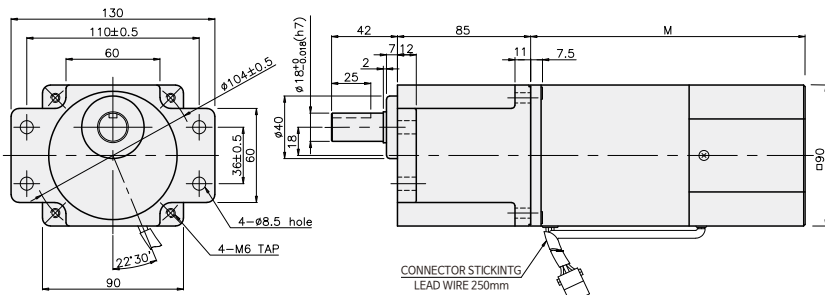

WEIGHT

PART	WEIGHT(kg)
MOTOR	3.54
DECIMAL GEARHEAD	0.62

DIMENSION TABLE

PART No.	M	Application Model
01	195	50Hz
02	175	60Hz

DIMENSION TABLE

PART No.	Application Model	Mounting BOLT
01	K9P3~200B	M6 P1.0 × 95
02	K9P10BX	M6 P1.0 × 140

WEIGHT

PART	WEIGHT(kg)
K9P3~10B	1.22
K9P12.5~20B	1.32
K9P25~60B	1.42
K9P75~200B	1.45

DIMENSION TABLE

PART No.	Application Model	Mounting BOLT
01	K9P3~200BF	M6 P1.0 × 20
02	K9P10BX	M6 P1.0 × 65

WEIGHT

PART	WEIGHT(kg)
K9P3~10BF	1.22
K9P12.5~20BF	1.30
K9P25~60BF	1.42
K9P75~200BF	1.44

DIMENSION TABLE

PART No.	Application Model	Mounting BOLT
01	K9P3~200BU	M6 P1.0 × 20
02	K9P10BX	M6 P1.0 × 65

WEIGHT

PART	WEIGHT(kg)
K9P3~10BU	1.44
K9P12.5~20BU	1.55
K9P25~60BU	1.69
K9P75~200BU	1.74

DIMENSION TABLE

PART No.	Application Model	Mounting BOLT
01	K9P3~200BUF	M6 P1.0 × 20
02	K9P10BX	M6 P1.0 × 65

WEIGHT

PART	WEIGHT(kg)
K9P3~10BUF	1.50
K9P12.5~20BUF	1.62
K9P25~60BUF	1.76
K9P75~200BUF	1.82