

BRAKE MOTOR

150W

□90mm

K9□S150F□-B

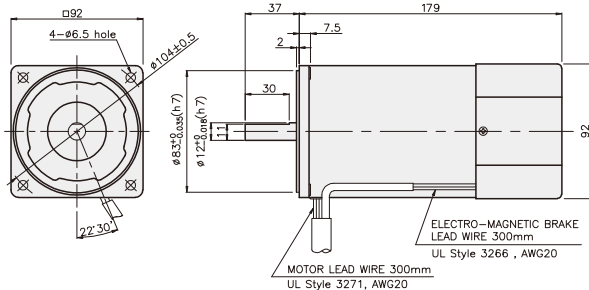

DIMENSION TABLE

PART No	M	Application Model
K9IS150F□-B-C50	200	50Hz
K9IS150F□-B	179	60Hz

※ 50Hz motor is "C50" added to model number.

SPECIFICATIONS

150W continuous rating, four poles

Model	Duty	Voltage (V)	Frequency (Hz)	Current (A)	Start T. (N·m/kgf·cm)	Rated T. (N·m/kgf·cm)	Speed (rpm)	Condenser (μF)	Friction T. (N·m/kgf·cm)
K9I□150FT-B-C50	three-phase continuous	200	50	1,2	3,5/35	1,13/11,3	1300	-	1/10
K9I□150FT-B			60	0,95	2,65/26,5	0,915/9,15	1600		
K9I□150FH-B-C50		220	50	0,99	2,95/29,5	1,13/11,3	1300	-	1/10
				230	1,1				
K9I□150FH-B		220	60	0,97	2,5/25	0,915/9,15	1600	-	1/10
				230	1,02				
K9I□150FM-B-C50		380	50	0,57	3/30	1,13/11,3	1300	-	1/10
K9I□150FM-B									
K9I□150FV-B-C50		400	50	0,6	3,5/35	1,13/11,3	1300	-	1/10
K9I□150FQ-B-C50		415	50	0,57	3,15/31,5	1,13/11,3	1300	-	1/10
K9I□150FZ-B-C50		440	50	0,53	3,3/33	1,085/10,85	1350	-	1/10

* □ : SHAFT SHAPE (S : STRAIGHT, P : PINION) * 3 phase motor for over 380 voltage can't be used with inverter. Motor winding insulation can be damaged.

RATED TORQUE OF GEARHEAD

● 50Hz

unit = above : N·m / below : Kgf·cm

Model	Speed(rpm)	500	416	300	250	200	166	150	120	100	83	75	60	50	41	37	30	25	20	16	15	13	10	8,3	7,5
Motor/ Gearhead	Ratio	3	3,6	5	6	7,5	9	10	12,5	15	18	20	25	30	36	40	50	60	75	90	100	120	150	180	200
K9IP150F□-B K9P□B, BF		2,64	3,16	4,39	5,27	6,59	7,91	8,79	9,89	11,86	14,24	15,82	17,80	20	20	20	20	20	20	20	20	20	20	20	20
		26,4	31,6	43,9	52,7	65,9	79,1	87,9	98,9	118,6	142,4	158,2	178,0	200	200	200	200	200	200	200	200	200	200	200	200

● 60Hz

unit = above : N·m / below : Kgf·cm

Model	Speed(rpm)	600	500	360	300	240	200	180	144	120	100	90	72	60	50	45	36	30	24	20	18	15	12	10	9
Motor/ Gearhead	Ratio	3	3,6	5	6	7,5	9	10	12,5	15	18	20	25	30	36	40	50	60	75	90	100	120	150	180	200
K9IP150F□-B K9P□B, BF		2,22	2,67	3,71	4,45	5,56	6,67	7,41	8,34	10,01	12,01	13,34	15,01	18,01	20	20	20	20	20	20	20	20	20	20	20
		22,2	26,7	37,1	44,5	55,6	66,7	74,1	83,4	100,1	120,1	133,4	150,1	180,1	200	200	200	200	200	200	200	200	200	200	200

* Gearhead and decimal gearhead are sold separately.

* The code in □ of gearhead model is for gear ratio.

* ■ color indicates that the output shaft of the geared motor rotates in the same direction as the output shaft of the motor. Others indicate rotation in the opposite direction.

* If you are to have less ratio than the ratio in the table, you can install the decimal gearhead, which has one tenth of the ratio, between the gearhead and the motor. In this case, the permissible torque is 20N·m/200kgf·cm.

* RPM is based on motor's synchronous rpm (50HZ:1500rpm, 60HZ:1800rpm) and calculated by dividing gear ratio. Actual rpm is 2~20% less than indicating rpm according to load size.

GEARHEADS

RATED TORQUE OF GEARHEAD

● 50Hz

unit = above : N · m / below : kgfcm

Model	Speed(rpm)	500	416	300	250	200	166	150	120	100	83	75	60	50	41	37	30	25	20	16	15	13	10	8,3	7,5
Motor/ Gearhead	Ratio	3	3,6	5	6	7,5	9	10	12,5	15	18	20	25	30	36	40	50	60	75	90	100	120	150	180	200
K9IP150F□-B		2,64	3,16	4,39	5,27	6,59	7,91	8,79	9,89	11,86	14,24	15,82	17,80	21,36	25,63	28,47	30	30	30	30	30	30	30	30	30
K9P□BU, BUF		26,4	31,6	43,9	52,7	65,9	79,1	87,9	98,9	118,6	142,4	158,2	178,0	213,6	256,3	284,7	300	300	300	300	300	300	300	300	300

● 60Hz

unit = above : N · m / below : kgfcm

Model	Speed(rpm)	600	500	360	300	240	200	180	144	120	100	90	72	60	50	45	36	30	24	20	18	15	12	10	9
Motor/ Gearhead	Ratio	3	3,6	5	6	7,5	9	10	12,5	15	18	20	25	30	36	40	50	60	75	90	100	120	150	180	200
K9IP150F□-B		2,22	2,67	3,71	4,45	5,56	6,67	7,41	8,34	10,01	12,01	13,34	15,01	18,01	21,61	24,01	30	30	30	30	30	30	30	30	30
K9P□BU, BUF		22,2	26,7	37,1	44,5	55,6	66,7	74,1	83,4	100,1	120,1	133,4	150,1	180,1	216,1	240,1	300	300	300	300	300	300	300	300	300

- * Gearhead and decimal gearhead are sold separately.
- * The code in □ of gearhead model is for gear ratio.
- * color indicates that the output shaft of the geared motor rotates in the same direction as the output shaft of the motor. Others indicate rotation in the opposite direction.
- * If you are to have less ratio than the ratio in the table, you can install the decimal gearhead, which has one tenth of the ratio, between the gearhead and the motor. In this case, the permissible torque is 30N · m/300kgfcm.
- * RPM is based on motor's synchronous rpm (50HZ:1500rpm, 60HZ:1800rpm) and calculated by dividing gear ratio. Actual rpm is 2~20% less than indicating rpm according to load size.

CONNECTION DIAGRAMS

three phase motor

Connect Cr circuit for absorbing surge voltage as connection diagram to protect contact point.
 $R_o = 5 - 200\Omega$
 $C_o = 0,1 \sim 0,2\mu F$ 200WV(400WV)

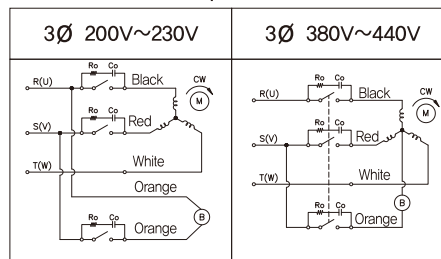

※The direction of motor rotation is as viewed from the front shaft end of the motor connecting two leadwires of U,V,W in turns

GEARHEADS

DIMENSIONS

K9P□B



K9P□BF, BUF

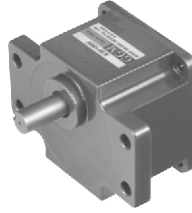

K9P□BU

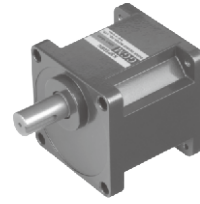

DECIMAL GEARHEAD

K9P10BX

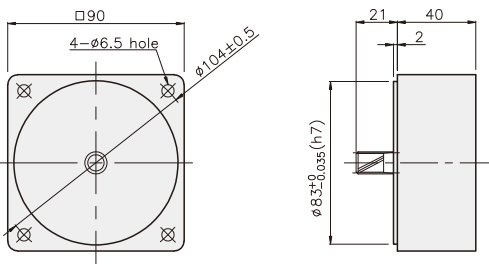

KEY SPEC

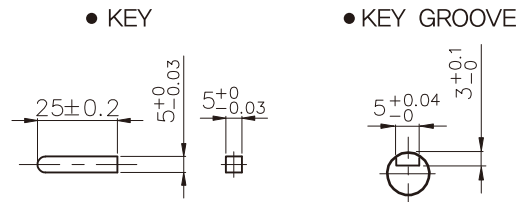

GEARHEAD

K9P□B

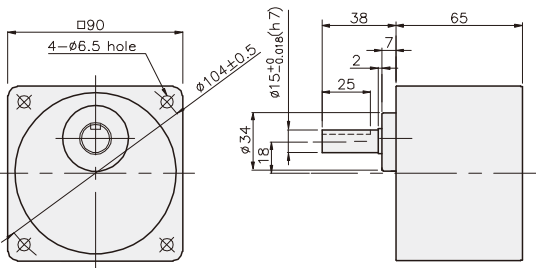

K9P□BF

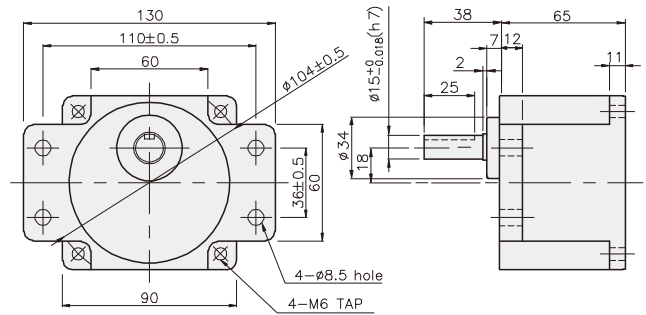

K9P□BU

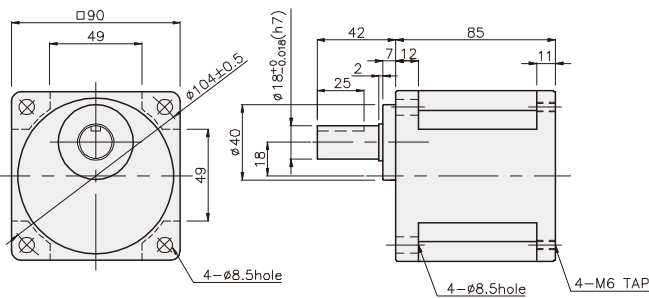

K9P□BUF

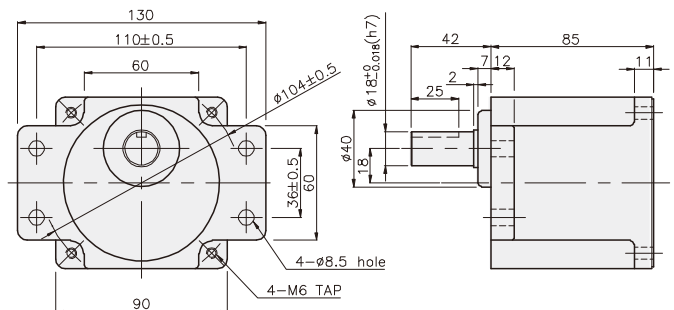

BRAKE MOTOR

GEARHEADS

DIMENSIONS

K9□P150F□-B + K9P□B

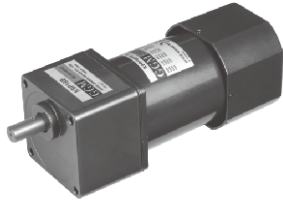

K9□P150F□-B + K9P□BF, BUF

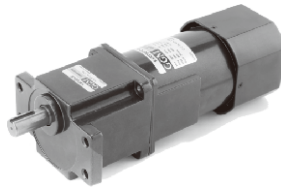

K9□P150F□-B + K9P□BU

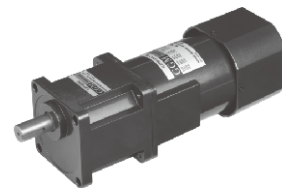

K9IP150F□-B + K9P□B

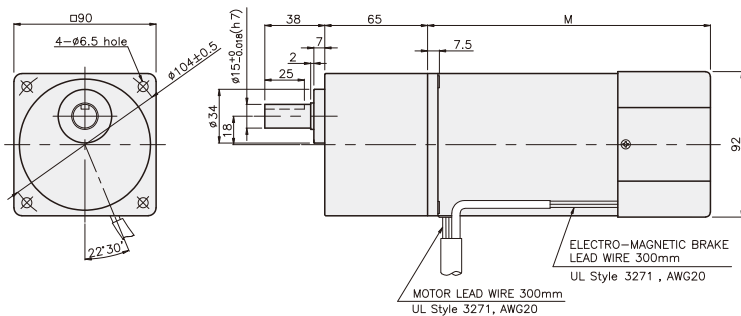

K9IP150F□-B + K9P□BF

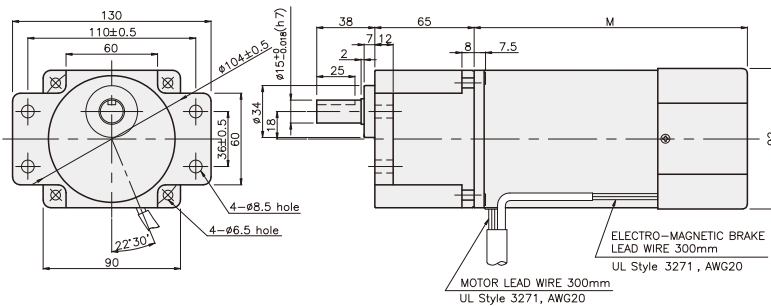

K9IP150F□-B + K9P□BU

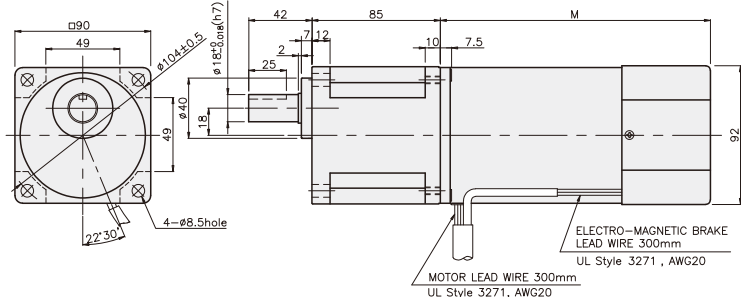

K9IP150F□-B + K9P□BUF

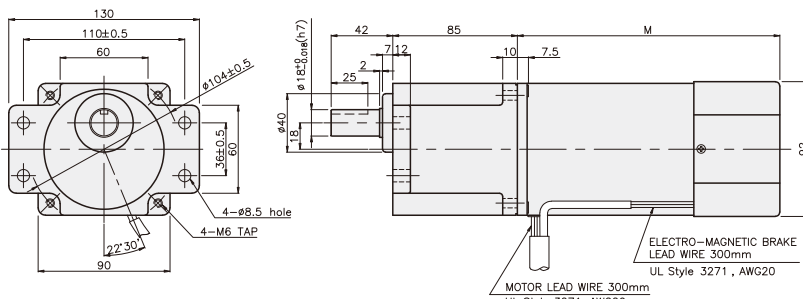

WEIGHT

PART	WEIGHT(kg)
MOTOR	4,38(50Hz)
	3,66(60Hz)
DECIMAL GEAR HEAD	0,62

DIMENSION TABLE

PART No	M	Application Model
01	155	50Hz
02	135	60Hz

DIMENSION TABLE

PART No	L	Application Model	Mounting BOLT
01	65	K9P3~200B	M6 P1,0 X 95
02	40	K9P10BX	M6 P1,0 X 140

WEIGHT

PART	WEIGHT(kg)
K9P3~10B	1,22
K9P12,5~20B	1,32
K9P25~60B	1,42
K9P75~200B	1,45

DIMENSION TABLE

PART No	L	Application Model	Mounting BOLT
01	65	K9P3~200BF	M6 P1,0 X 25
02	40	K9P10BX	M6 P1,0 X 65

WEIGHT

PART	WEIGHT(kg)
K9P3~10BF	1,22
K9P12,5~20BF	1,30
K9P25~60BF	1,42
K9P75~200BF	1,44

DIMENSION TABLE

PART No	L	Application Model	Mounting BOLT
01	85	K9P3~200BU	M6 P1,0 X 20
02	40	K9P10BX	M6 P1,0 X 60

WEIGHT

PART	WEIGHT(kg)
K9P3~10BU	1,44
K9P12,5~20BU	1,55
K9P25~60BU	1,69
K9P75~200BU	1,74

DIMENSION TABLE

PART No	L	Application Model	Mounting BOLT
01	85	K9P3~200BUF	M6 P1,0 X 20
02	40	K9P10BX	M6 P1,0 X 65

WEIGHT

PART	WEIGHT(kg)
K9P3~10BUF	1,50
K9P12,5~20BUF	1,62
K9P25~60BUF	1,76
K9P75~200BUF	1,82