

BRUSHLESS DC MOTOR UNIT - F Series

DIMENSIONS

K10FH200NC + K10H□BTH
 K10FH400NC + K10H□BTH
 (Weight : 7.3Kg)

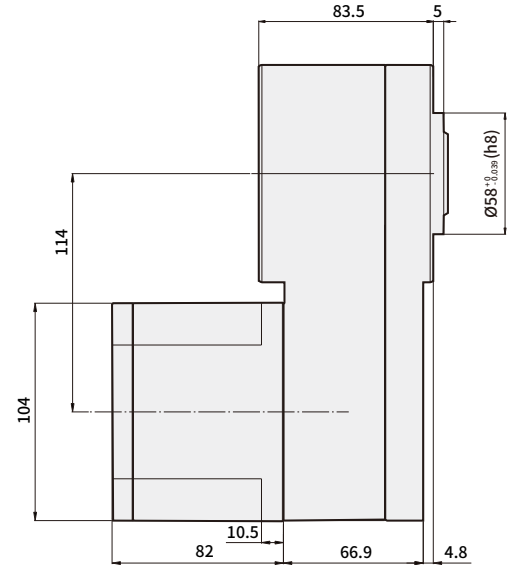
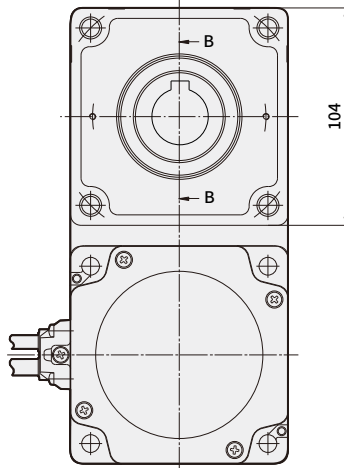

* KEY (ACCESSORY)

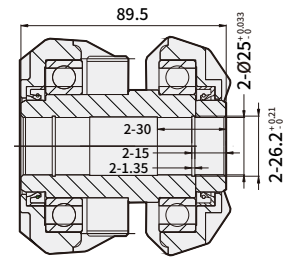
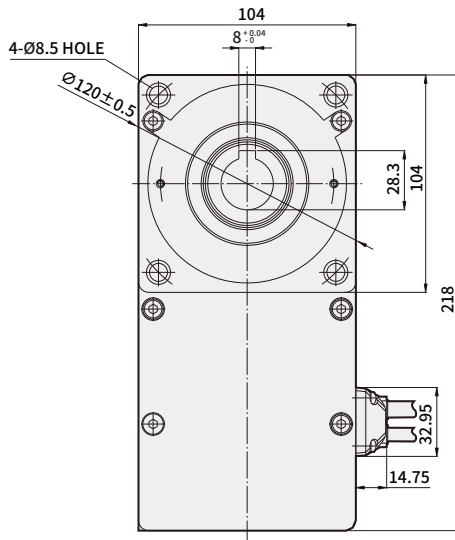
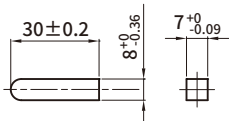

SECTION B-B

MOTOR PRODUCT NAME	GEARHEAD PRODUCT NAME	DECELERATION RATIO	FIXING BOLT
K10FH200NC K10FH400NC	K10H□BTH	5, 10, 15, 20 30, 50, 100	M8 P1.25×100

- * In Dimension, in ■ of name represents power voltage U(single-phase 100~115V), C(single-phase 200~230V)
- * 200NC, 400NC which are in end of the model name is UL certified ones. UL FILE NO. E504659
- * In □ of name, it represents a deceleration ratio.
- * Mounting bolt sets are included in flat type gearbox.
 M8×100L (flat washer, spring washer, hexagonal nut 4pcs each)

→ B-Series Specification

Product name	GEAR TYPE	K6BH30NU	K6BH30NC	K8BH60NU	K8BH60NC	K9BH90NU	K9BH90NC	K9BH150NC	
	D-CUT TYPE	K6BS30NU	K6BS30NC	K8BS60NU	K8BS60NC	K9BS90NU	K9BS90NC	K9BS150NC	
Rating output (continuous)	W	30		60		90		150	
Power input	Voltage(single-phase)	V	100~115	200~230	100~115	200~230	100~115	200~230	200~230
	Frequency	Hz	50/60						
	Rating input current	A	1.0	0.6	1.5	1.0	2.5	1.5	1.8
	Maximum input current	A	2.5	2.0	3.5	3.0	5.0	4	5
Rating torque	N·m	0.1		0.2		0.3		0.49	
Starting torque	N·m	0.15		0.3		0.5		0.6	
Rating rotation speed	r/min	3,000							
Speed control range	r/min	100 ~ 3,000							

→ F-Series Specification

Product name	GEAR TYPE	K6FH30NC	K8FH60NC	K9FH150NC	K10FH200NC	K10FH400NC	
	D-CUT TYPE	K6FS30NC	K8FS60NC	K9FS150NC	K10FS200NC	K10FS400NC	
Rating output (continuous)	W	30	60	150	200	400	
Power input	Voltage(single-phase)	V	single-phase 200~240V / three-phase 200~240V (Allowable range ±10%)				
	Frequency	Hz	50/60				
	Rating input current	A	single-phase : 0.8 three-phase : 0.5	single-phase : 1.0 three-phase : 0.7	single-phase : 2.0 three-phase : 1.2	single-phase : 2.5 three-phase : 1.8	single-phase : 4.0 three-phase : 3.0
	Maximum input current	A	single-phase : 1.9 three-phase : 1.1	single-phase : 2.8 three-phase : 1.7	single-phase : 4.5 three-phase : 2.6	single-phase : 5.5 three-phase : 3.2	single-phase : 7.8 three-phase : 5.0
Rated output current	A	0.17	0.43	0.95	1.60	2.30	
Rating torque	N·m	0.1	0.2	0.49	0.65	1.30	
Starting torque	N·m	0.15	0.3	0.60	1.15	1.80	
Rating rotation speed	r/min	3000					
Speed control range	r/min	100~4000					

→ Common Specification

Items		Motor	Control unit
Insulation Resistance		After continuously operating at room temperature and humidity, it should be greater than 100MΩ between coil and case when measured with DC 500V MEGA TESTER	Protection ground terminal and power input should be greater than 100MΩ when measure with DC 500V MEGA TESTER
Dielectric Strength		After continuously operating at room temperature and humidity, there shouldn't be any problem if 60Hz, 1500V is applied for more than 1 minute between coil and case	There shouldn't be any problem if 60Hz, 1500V is applied for more than 1 minute between protection ground terminal and power input
Temperature rise		After operating continuously at room temperature and humidity, the temperature increase should be less than 60°C and less than 50°C of temperature increase on the case surface when measure with thermo couple	
Used environment	Used Ambient temperature / Humidity	0°C~+50°C (There should not be any freeze) / less than 85% (no dew condensation)	
	Ambient environment	No corrosive gas or dusts	
Conservation environment	Ambient temperature / Humidity	-25 ~ +70°C (There should not be any freeze) / less than 85% (no dew)	
Insulation class		UL, CSA Standard A Type(105°C), EN Standard E Type(120°C)	
Protection class		IP65(Except for the mounting part on the output part)	IP10
Motor insulation class		E TYPE(120°C)	

→ Delivery efficiency of gearhead

Product name	Deceleration ratio	5	10	15	20	30	50	100	200
	K6H□B		90%				86%		
K8H□B		90%				86%			81%
K9H□B		90%				86%			81%
K10H□BU		90%				86%		81%	
K6H□BTH	80%	85%							
K8H□BTH		85%							
K9H□BTH		85%							
K10H□BTH		85%							

→ Allowed torque of combination type

Unit = N·m

Product name	Deceleration ratio	5	10	15	20	30	50	100	200
		Speed control range [r/min]	20~600	10~300	6.7~200	5~150	3.3~100	2~60	1~30
K6BH30N■ + K6H□B	100~3000	0.45	0.9	1.4	1.8	2.6	4.3	6	6
K8BH60N■ + K8H□B		0.9	1.8	2.7	3.6	5.2	8.6	16	16
K9BH90N■ + K9H□B		1.35	2.7	4.1	5.4	7.7	12.9	25.8	30
K9BH150NC + K9H□B		2.2	4.4	6.6	8.8	12.6	21.1	30	30
K6BH30N■ + K6H□BTH		0.4	0.85	1.3	1.7	2.6	4.3	8.5	17
K8BH60N■ + K8H□BTH		0.85	1.7	2.6	3.4	5.1	8.5	17	34
K9BH90N■ + K9H□BTH		1.9	3.8	5.7	7.7	11.5	19.1	38.3	68
K9BH150NC + K9H□BTH		2.1	4.2	6.2	8.3	12.5	21	42	68
Product name	Deceleration ratio	5	10	15	20	30	50	100	200
	Speed control range [r/min]	20~800	10~400	6.7~266	5~200	3.3~133	2~80	1~40	0.5~20
K6FH30NC+K6H□B	100~3000	0.45	0.9	1.4	1.8	2.6	4.3	6	6
	4000	0.36	0.72	1.08	1.4	2.1	3.4	5.4	5.4
K8FH60NC+K8H□B	100~3000	0.9	1.8	2.7	3.6	5.2	8.6	16	16
	4000	0.68	1.4	2.0	2.7	3.9	6.5	12.9	14
K9FH150NC+K9H□B	100~3000	2.2	4.4	6.6	8.8	12.6	21.1	30	30
	4000	1.4	2.7	4.1	5.4	7.7	12.9	25.8	27
K10FH200NC+K10H□BU	100~3000	2.9	5.9	8.8	11.7	16.8	28	52.7	70
	4000	2	4.1	6.1	8.1	11.6	19.4	36.5	63
K10FH400NC+K10H□BU	100~3000	5.9	11.7	17.6	23.4	33.5	55.9	70	70
	4000	4.3	8.6	12.8	17.1	24.5	40.9	63	63
K6FH30NC+K6H□BTH	100~3000	0.4	0.85	1.3	1.7	2.6	4.3	8.5	17
	4000	0.30	0.64	0.96	1.3	1.9	3.2	6.4	12.8
K8FH60NC+K8H□BTH	100~3000	0.85	1.7	2.6	3.4	5.1	8.5	17	34
	4000	0.64	1.3	1.9	2.6	3.8	6.4	12.8	25.5
K9FH150NC+K9H□BTH	100~3000	2.1	4.2	6.2	8.3	12.5	21	42	68
	4000	1.3	2.6	3.8	5.1	7.7	12.8	25.5	51
K10FH200NC+K10H□BTH	100~3000	2.8	5.5	8.3	11.1	16.6	27.6	55.3	—
	4000	1.9	3.8	5.7	7.7	11.5	19.1	38.3	—
K10FH400NC+K10H□BTH	100~3000	5.5	11.1	16.6	22.1	33.2	55.3	110	—
	4000	4.0	8.1	12.1	16.2	24.2	40.4	80.8	—

* In dimension, in ■ of name represents power voltage U(single-phase 100~115V), and C(single-phase 200~230V)

* Rotation direction shows the same □ color as the motor. In other cases, it's the opposite.

* Flat Gearbox viewed from front side is opposite rotation direction with motor.

* Flat Gearbox viewed from back side is same rotation direction with motor.

→ Allowed overhang load and allowed thrust

Product name		Deceleration ratio	Allowed overhand load				Allowed thrust load	
			From the end of output part 10mm		From the end of output part 20mm		N	kgf
			N	kgf	N	kgf		
GEARED MOTOR	K6BH30N■ (K6FH30NC) + K6H□B	5	100	10	150	15	40	4
		10,15,20	150	15	200	20		
		30,50,100,200	200	20	300	30		
	K8BH60N■ (K8FH60NC) + K8H□B	5	200	20	250	25	100	10
		10,15,20	300	30	350	35		
		30,50,100,200	450	45	550	55		
	K9BH90N■ K9BH150NC (K9FH150NC) + K9H□B	5	300	30	400	40	150	15
		10,15,20	400	40	500	50		
		30,50,100,200	500	50	650	65		
	K10FH200NC (K10FH400NC) + K10H□BU	5,10,15,20	550	55	800	80	200	20
		30,50	1000	100	1250	125	300	30
		100,200	1400	140	1700	170	400	40
	K6BH30N■ (K6FH30NC) + K6H□BTH	5,10	450	45	370	37	200	20
		15~200	500	50	400	40		
	K8BH60N■ (K8FH60NC) + K8H□BTH	5,10	800	80	660	66	400	40
		15~200	1200	120	1000	100		
	K9BH90N■ K9BH150NC (K9FH150NC) + K9H□BTH	5,10	900	90	770	77	500	50
		15,20	1300	130	1110	111		
		30,50,100,200	1500	150	1280	128		
	K10FH200NC (K10FH400NC) + K10H□BTH	5,10	1230	123	1070	107	800	80
15,20		1680	168	1470	147			
30,50,100		2040	204	1780	178			
MOTOR	K6BS30N■,K6FS30NC		70	7	100	10	· Do not apply THRUST load Please. If you can't help it, 50% or less.	
	K8BS60N■,K8FS60NC		120	12	140	14		
	K9BS90N■ K9BS150NC,K9FS150NC		160	16	170	17		
	K10FS200NC,K10FS400NC		197	19.7	220	22		

* In dimension, in ■ of name represents power voltage U(single-phase 100~115V),and C(single-phase 200~230V).

* In □ of name, it represents a deceleration ratio.

* Permissible overhang load can be withdrawn by calculation.

→ Rotation speed - torque characteristic

K6BS30N ■ / K6BH30N ■

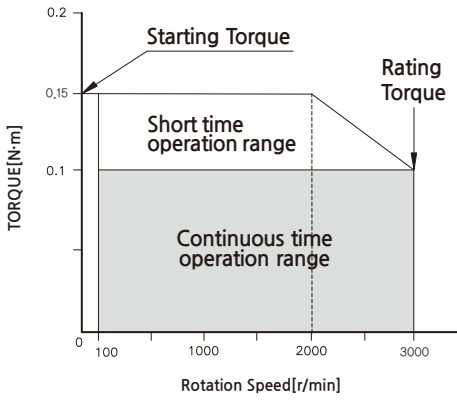

K8BS60N ■ / K8BH60N ■

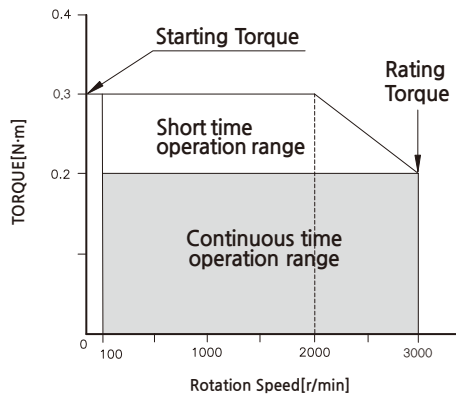

K9BS90N ■ / K9BH90N ■

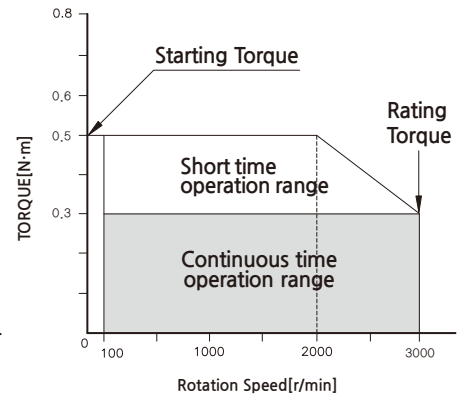

K9BS150NC / K9BH150NC

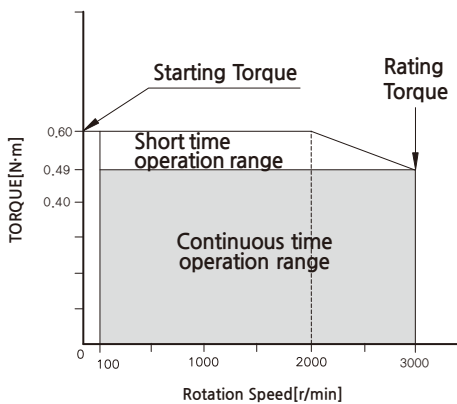

K6FS30NC / K6FH30NC

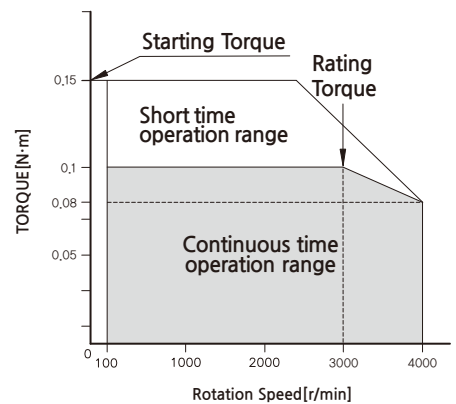

K8FS60NC / K8FH60NC

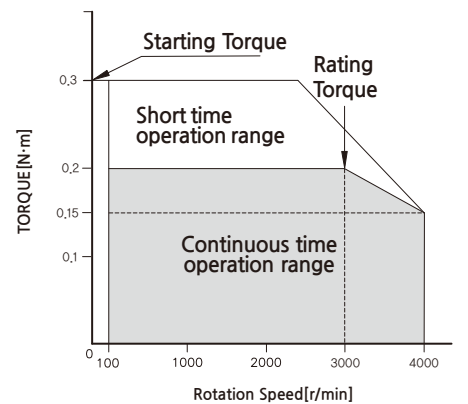

K9FS150NC / K9FH150NC

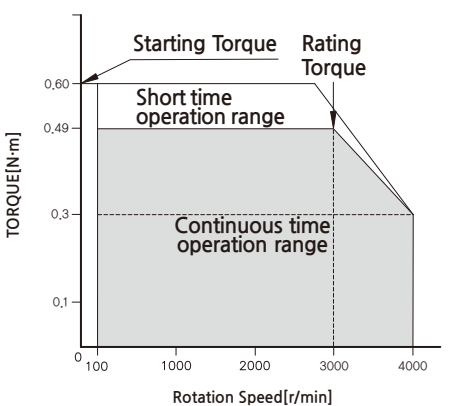

K10FS200NC / K10FH200NC

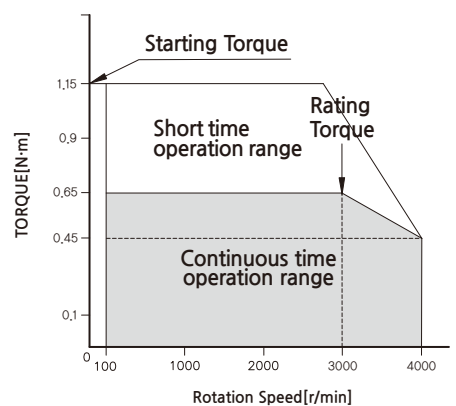

K10FS400NC / K10FH400NC

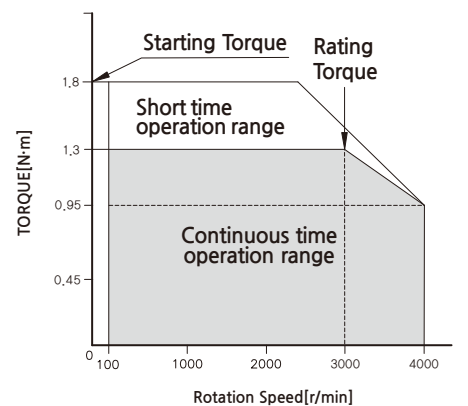

* In Dimension, in ■ of name represents power voltage U(single-phase 100~115V), C(single-phase 200~230V)