

BRAKE MOTOR

40W

□90mm

K9□S40N□-B

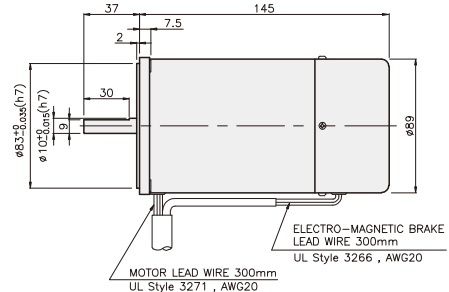
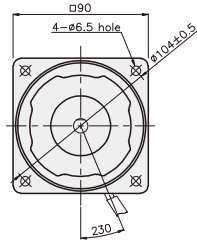

SPECIFICATIONS

40W 단상 : 30분 정격, 삼상 : 연속정격, 4극

Model	Duty	Voltage (V)	Frequency (Hz)	Current (A)	Start T. (N·m/kgf·cm)	Rated T. (N·m/kgf·cm)	Speed (rpm)	Condenser (μF)	Friction T. (N·m/kgf·cm)		
K9R□40NJ-B K9R□40NU-B K9R□40NL-B K9R□40NC-B K9R□40ND-B	단상 30분	100	50	1	0.3/3	0.315/3.15	1250	16	1/10		
			60	1.13	0.33/3.3	0.255/2.55	1550				
		K9R□40NU-B	110	60	50	0.8	0.2/2	0.26/2.6	1500	10	1/10
					60	0.83	0.22/2.2				
		K9R□40NL-B	200	50	50	0.45	0.3/3	0.315/3.15	1250	4	1/10
					60	0.57		0.26/2.6	1500		
		K9R□40NC-B	220	50	50	0.46	0.3/3	0.315/3.15	1250	3.5	1/10
					60	0.55	0.32/3.2	0.26/2.6	1500		
				230	50	0.55	0.4/4	0.315/3.15	1250		
					60	0.58	0.36/3.6	0.26/2.6	1500		
		K9R□40ND-B	240	50	0.41	0.34/3.4	0.3/3	1300	3	1/10	
		K9I□40NT-B K9I□40NH-B K9I□40NM-B K9I□40NV-B K9I□40NQ-B K9I□40NZ-B	삼상 연속	200	50	0.39	1/10	0.3/3	1300	-	1/10
60	0.32				0.78/7.8	0.245/2.45	1600				
K9I□40NH-B	220			50	50	0.33	0.95/9.5	0.29/2.9	1350	-	1/10
					60	0.31	0.78/7.8	0.245/2.45	1600		
K9I□40NM-B	230			50	50	0.41	1/10	0.29/2.9	1350	-	1/10
					60	0.32	0.83/8.3	0.245/2.45	1600		
K9I□40NV-B	380			50	50	0.18	1/10	0.29/2.9	1350	-	1/10
					60	0.18	0.78/7.8	0.245/2.45	1600		
K9I□40NV-B	400			50	50	0.18	1.15/11.5	0.29/2.9	1350	-	1/10
					60	0.19	0.88/8.8	0.245/2.45	1600		
K9I□40NQ-B	415			50	50	0.16	0.95/9.5	0.29/2.9	1350	-	1/10
					60	0.14	0.72/7.2	0.245/2.45	1600		
K9I□40NZ-B	440	50	50	0.19	1/10	0.29/2.9	1350	-	1/10		
			60	0.16	0.79/7.9	0.245/2.45	1600				

* □ : SHAFT 형상 (S : STRAIGHT, G : PINION)

* 삼상 380V이상 사양의 MOTOR는 INVERTER와의 조합에서는 사용 할 수 없습니다. MOTOR 권선의 절연이 열화되어 파손될 가능성이 있습니다.

RATED TORQUE OF GEARHEAD

● 50Hz

단위 = 상단 : N·m / 하단 : kgf·cm

Model Motor/ Gearhead	Speed(rpm) Ratio	500	416	300	250	200	166	150	120	100	83	75	60	50	41	37	30	25	20	16	15	12.5	10	8.3	7.5
		3	3.6	5	6	7.5	9	10	12.5	15	18	20	25	30	36	40	50	60	75	90	100	120	150	180	200
K9□G40N□-B K9G□B(C)	0.70	0.85	1.17	1.41	1.76	2.11	2.35	2.94	3.52	4.23	4.23	5.29	6.34	7.61	8.46	10	10	10	10	10	10	10	10	10	10
	7.0	8.5	11.7	14.1	17.6	21.1	23.5	29.4	35.2	42.3	42.3	52.9	63.4	76.1	84.6	100	100	100	100	100	100	100	100	100	100

● 60Hz

단위 = 상단 : N·m / 하단 : kgf·cm

Model Motor/ Gearhead	Speed(rpm) Ratio	600	500	360	300	240	200	180	144	120	100	90	72	60	50	45	36	30	24	20	18	15	12	10	9
		3	3.6	5	6	7.5	9	10	12.5	15	18	20	25	30	36	40	50	60	75	90	100	120	150	180	200
K9□G40N□-B K9G□B(C)	0.60	0.71	0.99	1.19	1.49	1.79	1.98	2.48	2.98	3.57	3.57	4.47	5.36	6.43	7.14	8.04	10	10	10	10	10	10	10	10	10
	6.0	7.1	9.9	11.9	14.9	17.9	19.8	24.8	29.8	35.7	35.7	44.7	53.6	64.3	71.4	80.4	100	100	100	100	100	100	100	100	100

* GEARHEAD-DECIMAL GEARHEAD는 별매입니다.

* GEARHEAD의 품명중 □에는 감속비가 들어갑니다.

* 색이 MOTOR와 같은 방향, 그 외에는 반대 방향입니다.

* 표의 감속비보다 더 감속하고자 할 경우는 GEARHEAD와 MOTOR 사이에 감속비 10의 DECIMAL GEARHEAD를 설치할 수 있습니다. 이 경우의 허용 TORQUE는 10 N·m / 100 kgf·cm 입니다.

* 회전수는 MOTOR의 동기 회전수 (50 Hz : 1500 rpm, 60 Hz : 1800 rpm)를 기준으로 하여 감속비로 나누어서 계산하였습니다. 실제의 회전수는 부하의 크기에 따라서 표시된 수치보다 2~20% 적습니다.

GEARHEAD

CONNECTION DIAGRAMS

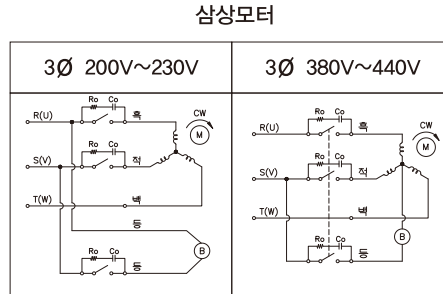
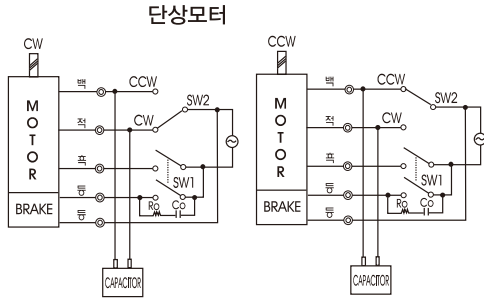

CCW는 U,V,W중
2선을 바꾸어 결선

※회전방향은 출력축에서 볼경우

점점 보호를 위해 결선도와 같이 서지(Surge) 전압 흡수용 Cr회로를 접속하여 주십시오.

Ro = 5 - 200Ω

Co = 0.1 ~ 0.2μF 200WV(400WV)

DIMENSIONS

K9G□B(C)



K9□G40N□-B + K9G□B(C)



DECIMAL GEARHEAD

K9G10BX

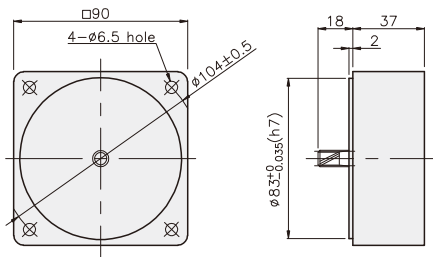

GEARHEAD

K9G□B(C)

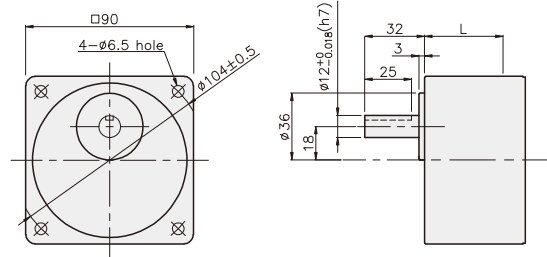

KEY SPEC

● KEY

● KEY GROOVE

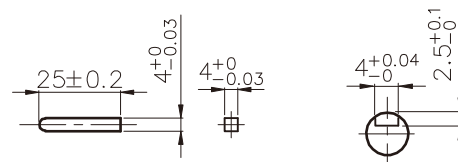

치수도표

품번	L	적용기종	취부 BOLT
01	42	K9G3~18B(C)	M6 P1.0 X 65
02	60	K9G20~200B(C)	M6 P1.0 X 80
03	37	K9G10BX	M6 P1.0 X 120

무게

PART	WEIGHT(kg)	
MOTOR	2.86	
DECIMAL GEARHEAD	0.60	
GEAR HEAD	K9G3~18B(C)	0.78
	K9G20~40B(C)	1.04
	K9G50~200B(C)	1.14

K9□G40N□-B + K9G□B(C)

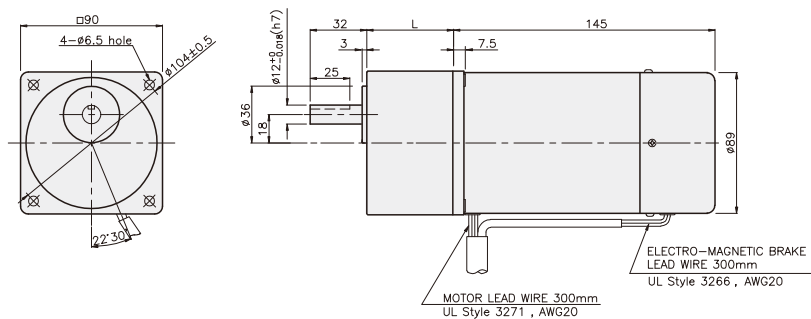

MOTOR LEAD WIRE 300mm
UL Style 3271, AWG20

ELECTRO-MAGNETIC BRAKE
LEAD WIRE 300mm
UL Style 3266, AWG20