

## BRAKE MOTOR

### 60W

### □90mm

K9□P60F□-B

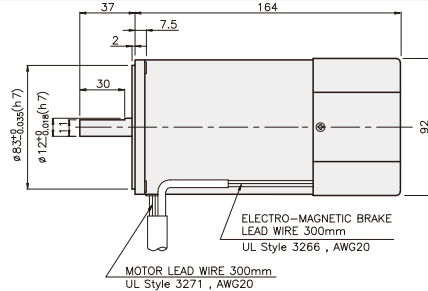
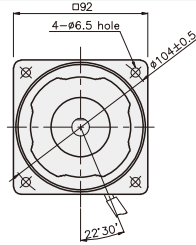

## SPECIFICATIONS

60W 단상 : 30분 정격, 삼상 : 연속정격, 4극

Model	Duty	Voltage (V)	Frequency (Hz)	Current (A)	Start T. (N·m/kgf·cm)	Rated T. (N·m/kgf·cm)	Speed (rpm)	Condenser (μF)	Friction T. (N·m/kgf·cm)
K9R□60FJ-B K9R□60FU-B K9R□60FL-B K9R□60FC-B K9R□60FD-B	단상	30분	100	50	1.48	0.48/4.8	0.47/4.7	25	1/10
				60	1.66		0.38/3.8		
			110	60	1.25	0.4/4	0.38/3.8	17	1/10
					1.31	0.425/4.25			
			200	50	0.72	0.5/5	0.47/4.7	6	1/10
					0.76	0.44/4.4			
			220	50	0.69	0.45/4.5	0.47/4.7	5	1/10
					0.76	0.48/4.8			
			230	50	0.77	0.5/5	0.47/4.7	5	1/10
					0.79				
240	50	0.75	0.5/5	0.47/4.7	5	1/10			
K9I□60FT-B K9I□60FH-B K9I□60FM-B K9I□60FV-B K9I□60FQ-B K9I□60FZ-B	삼상	연속	200	50	0.49	1.35/13.5	0.45/4.5	-	1/10
				60	0.45	1.05/10.5	0.38/3.8		
			220	50	0.55	1.6/16	0.435/4.35	-	1/10
					0.47	1.2/12	0.37/3.7		
			230	50	0.6	1.65/16.5	0.435/4.35	-	1/10
					0.52	1.3/13	0.37/3.7		
			380	50	0.34	1.55/15.5	0.435/4.35	-	1/10
					0.25	1.19/11.9	0.37/3.7		
			400	50	0.37	1.85/18.5	0.435/4.35	-	1/10
					0.28	1.42/14.2	0.37/3.7		
			415	50	0.26	1.45/14.5	0.45/4.5	-	1/10
					0.21	1.15/11.5	0.37/3.7		
440	50	0.28	1.6/16	0.45/4.5	-	1/10			
		0.23	1.25/12.5	0.37/3.7					

\* □ : SHAFT 형상 ( S : STRAIGHT, P : PINION ) \* 기종 명 끝에 FH-B 품번은 UL규격 인증 제품입니다. UL FILE NO. E204632  
\* 삼상 380V이상 사양의 MOTOR는 INVERTER와의 조합에서는 사용 할 수 없습니다. MOTOR 권선의 절연이 열화되어 파손될 가능성이 있습니다.

## RATED TORQUE OF GEARHEAD

### ● 50Hz

단위 = 상단 : N·m / 하단 : kgf·cm

Model Motor/ Gearhead	Speed(rpm)	500	416	300	250	200	166	150	120	100	83	75	60	50	41	37	30	25	20	16	15	12.5	10	8.3	7.5
	Ratio	3	3.6	5	6	7.5	9	10	12.5	15	18	20	25	30	36	40	50	60	75	90	100	120	150	180	200
K9□60F□-B K9P□B, BF	1.06	1.27	1.76	2.11	2.64	3.17	3.52	3.96	4.76	5.71	6.34	7.14	8.56	10.27	11.42	14.27	17.12	20	20	20	20	20	20	20	20
	10.6	12.7	17.6	21.1	26.4	31.7	35.2	39.6	47.6	57.1	63.4	71.4	85.6	102.7	114.2	142.7	171.2	200	200	200	200	200	200	200	200

### ● 60Hz

단위 = 상단 : N·m / 하단 : kgf·cm

Model Motor/ Gearhead	Speed(rpm)	600	500	360	300	240	200	180	144	120	100	90	72	60	50	45	36	30	24	20	18	15	12	10	9
	Ratio	3	3.6	5	6	7.5	9	10	12.5	15	18	20	25	30	36	40	50	60	75	90	100	120	150	180	200
K9□60F□-B K9P□B, BF	0.90	1.08	1.50	1.80	2.25	2.70	3.00	3.37	4.05	4.86	5.39	6.07	7.28	8.74	9.71	12.14	14.57	16.39	19.66	20	20	20	20	20	20
	9.0	10.8	15.0	18.0	22.5	27.0	30.0	33.7	40.5	48.6	53.9	60.7	72.8	87.4	97.1	121.4	145.7	163.9	196.6	200	200	200	200	200	200

\* GEARHEAD·DECIMAL GEARHEAD는 별매입니다.  
\* GEARHEAD의 품명중 □에는 감속비가 들어갑니다.  
\* 색이 MOTOR와 같은 방향, 그 외에는 반대 방향입니다.  
\* 표의 감속비보다 더 감속하고자 할 경우는 GEARHEAD와 MOTOR 사이에 감속비 10의 DECIMAL GEARHEAD를 설치할 수 있습니다.  
이 경우의 허용 TORQUE는 20 N·m / 200 kgf·cm 입니다.  
\* 회전수는 MOTOR의 동기 회전수 (50 Hz : 1500 rpm, 60 Hz : 1800 rpm)를 기준으로 하여 감속비로 나누어서 계산하였습니다.  
실제의 회전수는 부하의 크기에 따라서 표시된 수치보다 2~20% 적습니다.

## GEARHEAD

### CONNECTION DIAGRAMS

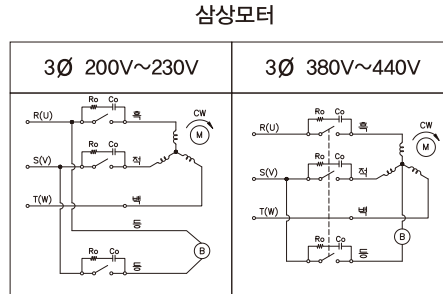
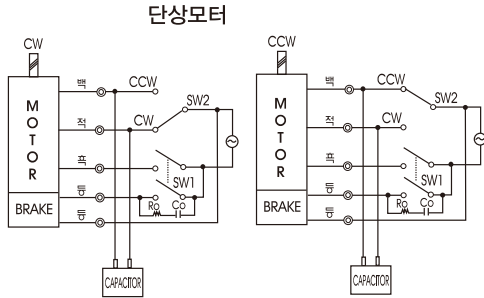

CCW는 U,V,W중  
2선을 바꾸어 결선

※회전방향은 출력축에서 볼경우

접점 보호를 위해 결선도와 같이 서지(Surge) 전압 흡수용 Cr회로를 접속하여 주십시오.

Ro = 5 - 200Ω  
Co = 0.1 ~ 0.2μF 200WV(400WV)

### DIMENSIONS

K9P□B



K9P□BF



### DECIMAL GEARHEAD

K9P10BX

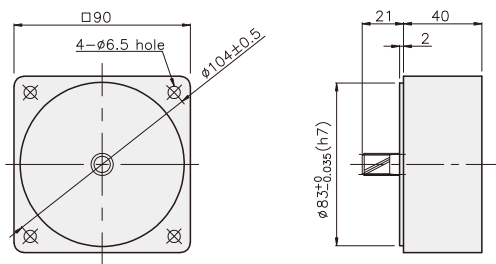

### KEY SPEC

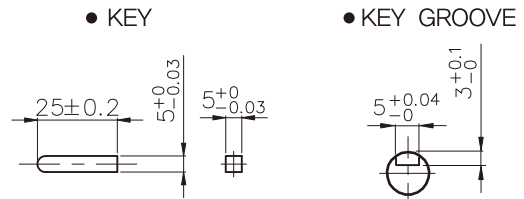

### GEARHEAD

K9P□B

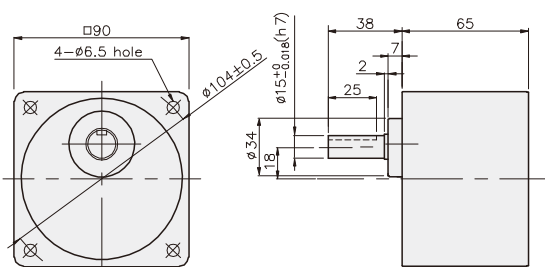

K9P□BF

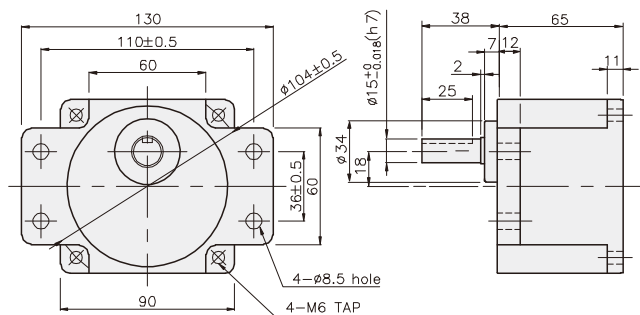

## GEARHEAD

### DIMENSIONS

K9□P60F□-B + K9P□B



K9□P60F□-B + K9P□BF



K9□P60F□-B + K9P□B

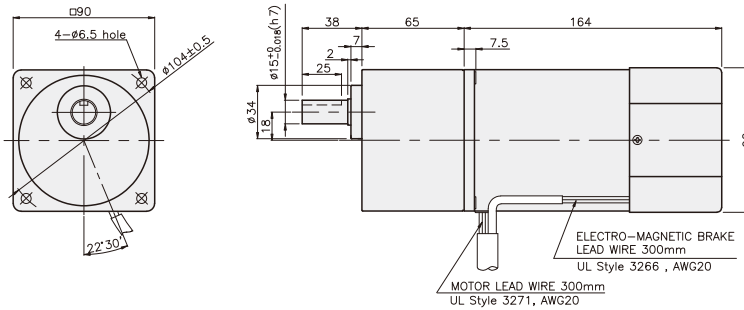

#### 치수도표

품번	적용기종	취부 BOLT
01	K9P3~200B	M6 P1,0 X 95
02	K9P10BX	M6 P1,0 X 140

#### 무게

PART	WEIGHT(kg)	
MOTOR	3,08	
DECIMAL GEARHEAD	0,62	
GEAR HEAD	K9P3~10B	1,22
	K9P12.5~20B	1,32
	K9P25~60B	1,42
	K9P75~200B	1,45

K9□P60F□-B + K9P□BF

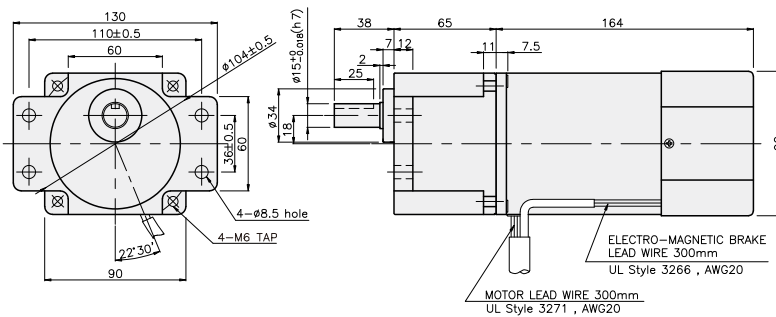

#### 치수도표

품번	적용기종	취부 BOLT
01	K9P3~200BF	M6 P1,0 X 20
02	K9P10BX	M6 P1,0 X 65

#### 무게

PART	WEIGHT(kg)	
MOTOR	3,08	
DECIMAL GEARHEAD	0,62	
GEAR HEAD	K9P3~10BF	1,22
	K9P12.5~20BF	1,30
	K9P25~60BF	1,42
	K9P75~200BF	1,44