

GEARHEAD

RATED TORQUE OF GEARHEAD

● 50Hz

단위 = 상단 : N·m / 하단 : kgf·cm

Model	Speed(rpm)	500	416	300	250	200	166	150	120	100	83	75	60	50	41	37	30	25	20	16	15	13	10	8,3	7,5
Motor/ Gearhead	Ratio	3	3,6	5	6	7,5	9	10	12,5	15	18	20	25	30	36	40	50	60	75	90	100	120	150	180	200
K9□P90F□-B		1,58	1,90	2,63	3,16	3,95	4,74	5,27	5,92	7,11	8,53	9,48	10,66	12,79	15,35	17,06	21,32	25,59	30	30	30	30	30	30	30
K9P□BU, BUF		15,8	19,0	26,3	31,6	39,5	47,4	52,7	59,2	71,1	85,3	94,8	106,6	127,9	153,5	170,6	213,2	255,9	300	300	300	300	300	300	300

● 60Hz

단위 = 상단 : N·m / 하단 : kgf·cm

Model	Speed(rpm)	600	500	360	300	240	200	180	144	120	100	90	72	60	50	45	36	30	24	20	18	15	12	10	9
Motor/ Gearhead	Ratio	3	3,6	5	6	7,5	9	10	12,5	15	18	20	25	30	36	40	50	60	75	90	100	120	150	180	200
K9□P90F□-B		1,34	1,60	2,23	2,67	3,34	4,01	4,46	5,01	6,01	7,22	8,02	9,02	10,83	12,99	14,43	18,04	21,65	24,36	30	30	30	30	30	30
K9P□BU, BUF		13,4	16,0	22,3	26,7	33,4	40,1	44,6	50,1	60,1	72,2	80,2	90,2	108,3	129,9	144,3	180,4	216,5	243,6	300	300	300	300	300	300

- * GEARHEAD·DECIMAL GEARHEAD는 별매입니다.
- * GEARHEAD의 품명중 □에는 감속비가 들어갑니다.
- * ■ 색이 MOTOR와 같은 방향, 그 외에는 반대 방향입니다.
- * 표의 감속비보다 더 감속하고자 할 경우는 GEARHEAD와 MOTOR 사이에 감속비 10의 DECIMAL GEARHEAD를 설치할 수 있습니다. 이 경우의 허용 TORQUE는 30 N·m / 300 kgf·cm 입니다.
- * 회전수는 MOTOR의 동기 회전수 (50 Hz : 1500 rpm, 60 Hz : 1800 rpm)를 기준으로 하여 감속비로 나누어서 계산하였습니다. 실제의 회전수는 부하의 크기에 따라서 표시된 수치보다 2~20% 적습니다.

CONNECTION DIAGRAMS

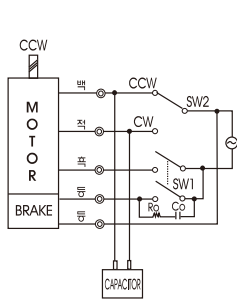
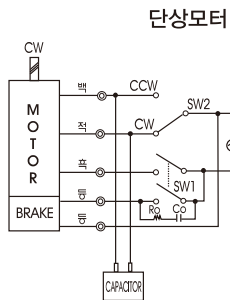

삼상모터

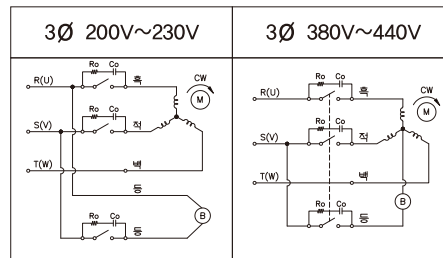

CCW는 U,V,W중
2선을 바꾸어 결선

※ 회전방향은 출력축에서 볼 경우

접점 보호를 위해 결선도와 같이 서지(Surge) 전압 흡수용 Cr회로를 접속하여 주십시오.
Ro = 5 - 200Ω
Co = 0,1 ~ 0,2μF 200WV(400WV)

GEARHEAD

DIMENSIONS

K9P□B



K9P□BF, BUF

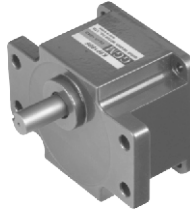

K9P□BU

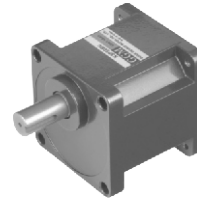

DECIMAL GEARHEAD

K9P10BX

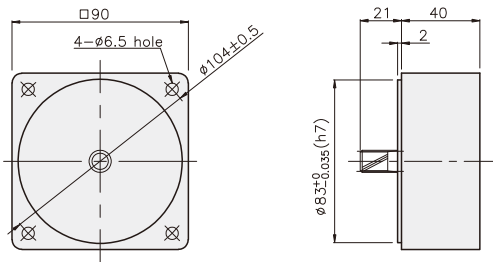

KEY SPEC

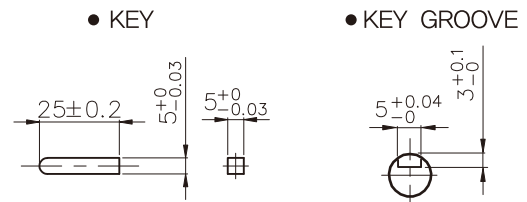

GEARHEAD

K9P□B

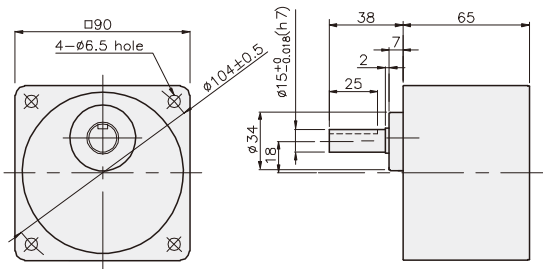

K9P□BF

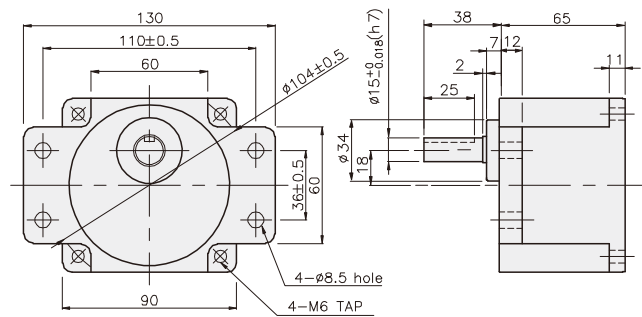

K9P□BU

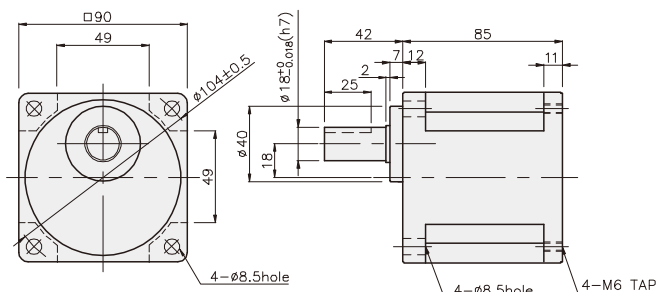

K9P□BUF

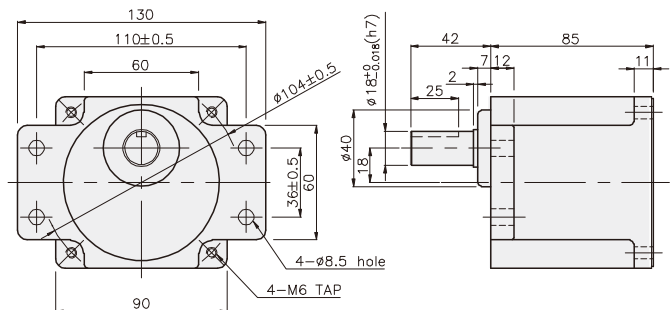

GEARHEAD

DIMENSIONS

K9□P90F□-B + K9P□B



K9□P90F-B + K9P□BF, BUF



K9□P90F□-B + K9P□BU



K9□P90F□-B + K9P□B

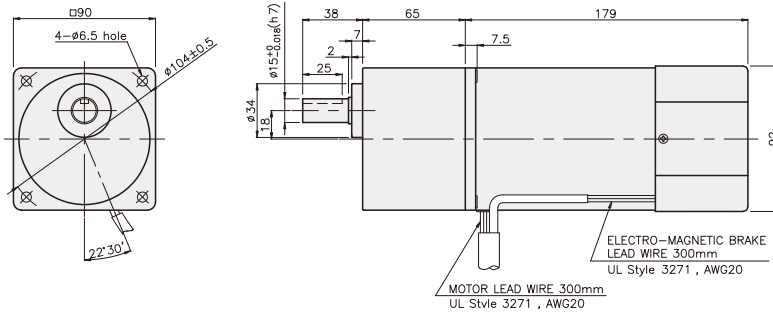

K9□P90F-B + K9P□BF

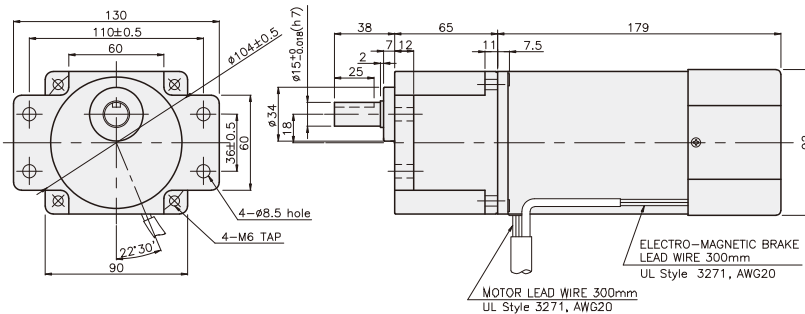

K9□P90F□-B + K9P□BU

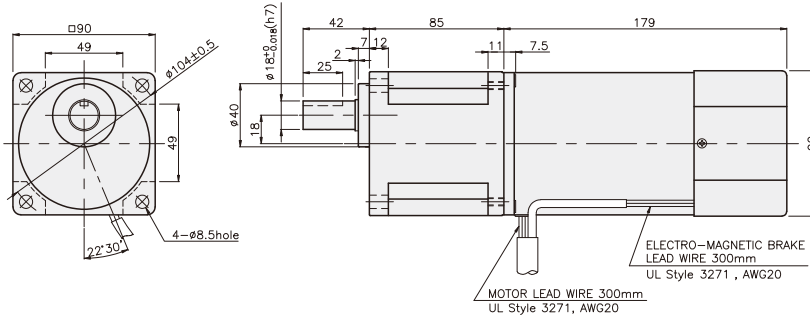

K9□P90F□-B + K9P□BUF

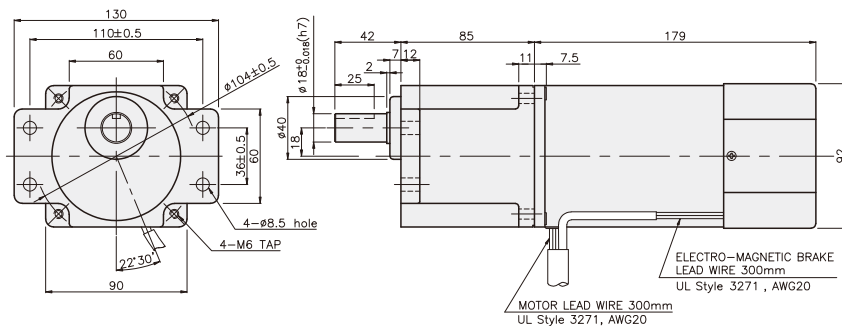

무게

PART	WEIGHT(kg)
MOTOR	3.60
DECIMAL GEARHEAD	0.62

치수도표

품번	적용기종	취부 BOLT
01	K9P3~200B	M6 P1,0 X 95
02	K9P10BX	M6 P1,0 X 140

무게

PART	WEIGHT(kg)
K9P3~10B	1.22
K9P12,5~20B	1.32
K9P25~60B	1.42
K9P75~200B	1.45

치수도표

품번	적용기종	취부 BOLT
01	K9P3~200BF	M6 P1,0 X 20
02	K9P10BX	M6 P1,0 X 65

무게

PART	WEIGHT(kg)
K9P3~10BF	1.22
K9P12,5~20BF	1.30
K9P25~60BF	1.42
K9P75~200BF	1.44

치수도표

품번	적용기종	취부 BOLT
01	K9P3~200BU	M6 P1,0 X 20
02	K9P10BX	M6 P1,0 X 65

무게

PART	WEIGHT(kg)
K9P3~10BU	1.44
K9P12,5~20BU	1.55
K9P25~60BU	1.69
K9P75~200BU	1.74

치수도표

품번	적용기종	취부 BOLT
01	K9P3~200BUF	M6 P1,0 X 20
02	K9P10BX	M6 P1,0 X 65

무게

PART	WEIGHT(kg)
K9P3~10BUF	1.50
K9P12,5~20BUF	1.62
K9P25~60BUF	1.76
K9P75~200BUF	1.82