

SPEED CONTROL MOTOR - SU SERIES

90W

□90mm

REVERSIBLE MOTOR

K9RS90F□-SU

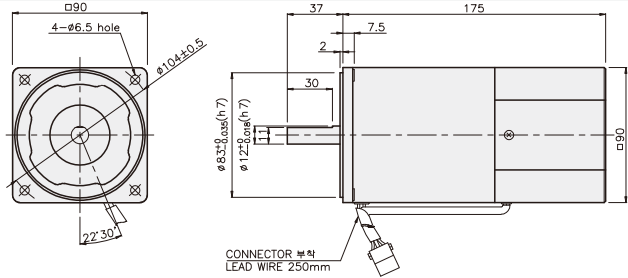
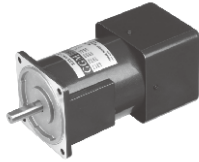

SPECIFICATIONS

90W 30분 정격, 4극

Model	Voltage (V)	Frequency (Hz)	Speed (rpm)	Permissible Torque		Start T. (N·m/kgf·cm)	Current (A)	Condenser (μF)	
				1200rpm (N·m/kgf·cm)	90rpm (N·m/kgf·cm)				
K9R□90FJ-SU	100	50	90 ~ 1400	0.75/7.5	0.25/2.5	0.4/4	3.6	35	
			90 ~ 1700						
K9R□90FU-SU	110	60	90 ~ 1700						
			115			0.38/3.8	3	25	
K9R□90FL-SU	200	50	90 ~ 1400						
			60			0.4/4	1.4	8	
K9R□90FC-SU	220	50	90 ~ 1400						
			60			0.25/2.5	1.2	7	
	230	50	90 ~ 1400						
			60			0.43/4.3	1.2		
K9R□90FD-SU	240	50	90 ~ 1400						0.25/2.5

* □ : SHAFT 형상 (S : STRAIGHT, P : PINION)

RATED TORQUE OF GEARHEAD

● 단상 100V/115V

단위 = 상단 : N·m / 하단 : kgf·cm

Model Motor/Gearhead	Ratio Speed(rpm)	3	3.6	5	6	7.5	9	10	12.5	15	18	20	25	30	36	40	50	60	75	90	100	120	150	180	200
		K9R□90F□-SU K9P□B, BF	1200	1.82 18.2	2.04 20.4	3.04 30.4	3.65 36.5	4.56 45.6	5.47 54.7	6.08 60.8	6.83 68.3	8.20 82.0	9.84 98.4	10.94 109.4	12.30 123.0	14.76 147.6	17.71 177.1	19.68 196.8	20	20	20	20	20	20	20
90	0.61 6.1		0.73 7.3	1.01 10.1	1.22 12.2	1.52 15.2	1.82 18.2	2.03 20.3	2.28 22.8	2.73 27.3	3.28 32.8	3.65 36.5	4.10 41.0	4.92 49.2	5.90 59.0	6.56 65.6	8.20 82.0	9.84 98.4	11.07 110.7	13.29 132.9	14.76 147.6	17.71 177.1	20	20	20

● 단상 200V/240V

단위 = 상단 : N·m / 하단 : kgf·cm

Model Motor/Gearhead	Ratio Speed(rpm)	3	3.6	5	6	7.5	9	10	12.5	15	18	20	25	30	36	40	50	60	75	90	100	120	150	180	200	
		K9R□90F□-SU K9P□B, BF	1200	1.82 18.2	2.19 21.9	3.04 30.4	3.65 36.5	4.56 45.6	5.47 54.7	6.08 60.8	6.83 68.3	8.20 82.0	9.84 98.4	10.94 109.4	12.30 123.0	14.76 147.6	17.71 177.1	19.68 196.8	20	20	20	20	20	20	20	20
90	200V/220V 230V/240V 50Hz		0.61 6.1	0.73 7.3	1.01 10.1	1.22 12.2	1.52 15.2	1.82 18.2	2.03 20.3	2.28 22.8	2.73 27.3	3.28 32.8	3.65 36.5	4.10 41.0	4.92 49.2	5.90 59.0	6.56 65.6	8.20 82.0	9.84 98.4	11.07 110.7	13.29 132.9	14.76 147.6	17.71 177.1	20	20	20
	200V/220V 230V/60Hz		0.68 6.8	0.82 8.2	1.13 11.3	1.36 13.6	1.70 17.0	2.04 20.4	2.27 22.7	2.55 25.5	3.06 30.6	3.67 36.7	4.08 40.8	4.59 45.9	5.51 55.1	6.61 66.1	7.35 73.5	9.19 91.9	11.02 110.2	12.40 124.0	14.88 148.8	16.53 165.3	19.84 198.4	20	20	20

- * GEARHEAD·DECIMAL GEARHEAD는 별매입니다.
- * GEARHEAD의 품명중 □에는 감속비가 들어갑니다.
- * 색이 MOTOR와 같은 방향, 그 외에는 반대 방향입니다.
- * 표의 감속비보다 더 감속하고자 할 경우는 GEARHEAD와 MOTOR 사이에 감속비 10의 DECIMAL GEARHEAD를 설치할 수 있습니다. 이 경우의 허용 TORQUE는 20 N·m / 200 kgf·cm 입니다.
- * 회전수는 MOTOR의 동기 회전수 (50 Hz : 1500 rpm, 60 Hz : 1800 rpm)를 기준으로 하여 감속비로 나누어서 계산하였습니다. 실제의 회전수는 부하의 크기에 따라서 표시된 수치보다 2~20% 적습니다.

SPEED CONTROL MOTOR - SU SERIES

GEARHEAD

RATED TORQUE OF GEARHEAD

● 단상 100V/115V

단위 = 상단 : N·m / 하단 : kgf·cm

Model	Ratio	3	36	5	6	7.5	9	10	12.5	15	18	20	25	30	36	40	50	60	75	90	100	120	150	180	200
Motor/Gearhead	Speed(rpm)																								
K9R□90F□-SU K9P□BU, BUF	1200	1.82 18.2	2.19 21.9	3.04 30.4	3.65 36.5	4.56 45.6	5.47 54.7	6.08 60.8	6.83 68.3	8.20 82.0	9.84 98.4	10.94 109.4	12.30 123.0	14.76 147.6	17.71 177.1	19.68 196.8	24.60 246	29.52 295	30 300	30 300	30 300	30 300	30 300	30 300	30 300
	90	0.61 6.1	0.73 7.3	1.01 10.1	1.22 12.2	1.52 15.2	1.82 18.2	2.03 20.3	2.28 22.8	2.73 27.3	3.28 32.8	3.65 36.5	4.10 41.0	4.92 49.2	5.90 59.0	6.56 65.6	8.20 82.0	9.84 98.4	11.07 110.7	13.29 132.9	14.76 147.6	17.71 177.1	22.14 221.4	26.57 265.7	29.52 295.2

● 단상 200V/240V

단위 = 상단 : N·m / 하단 : kgf·cm

Model	Ratio	3	36	5	6	7.5	9	10	12.5	15	18	20	25	30	36	40	50	60	75	90	100	120	150	180	200	
Motor/Gearhead	Speed(rpm)																									
K9R□90F□-SU K9P□BU, BUF	1200	1.82 18.2	2.19 21.9	3.04 30.4	3.65 36.5	4.56 45.6	5.47 54.7	6.08 60.8	6.83 68.3	8.20 82.0	9.84 98.4	10.94 109.4	12.30 123.0	14.76 147.6	17.71 177.1	19.68 196.8	24.60 246	29.52 295	30 300	30 300	30 300	30 300	30 300	30 300	30 300	
	90	200V/220V 230V/240V 50Hz	0.61 6.1	0.73 7.3	1.01 10.1	1.22 12.2	1.52 15.2	1.82 18.2	2.03 20.3	2.28 22.8	2.73 27.3	3.28 32.8	3.65 36.5	4.10 41.0	4.92 49.2	5.90 59.0	6.56 65.6	8.20 82.0	9.84 98.4	11.07 110.7	13.29 132.9	14.76 147.6	17.71 177.1	22.14 221.4	26.57 265.7	29.52 295.2
		200V/220V 230V/60Hz	0.68 6.8	0.82 8.2	1.13 11.3	1.36 13.6	1.70 17.0	2.04 20.4	2.27 22.7	2.55 25.5	3.06 30.6	3.67 36.7	4.08 40.8	4.59 45.9	5.51 55.1	6.61 66.1	7.35 73.5	9.19 91.9	11.02 110.2	12.40 124.0	14.88 148.8	16.53 165.3	19.84 198.4	24.80 248.0	29.76 297.6	30 300

- * GEARHEAD·DECIMAL GEARHEAD는 별매입니다.
- * GEARHEAD의 품명중 □에는 감속비가 들어갑니다.
- * ■ 색이 MOTOR와 같은 방향, 그 외에는 반대 방향입니다.
- * 표의 감속비보다 더 감속하고자 할 경우는 GEARHEAD와 MOTOR 사이에 감속비 10의 DECIMAL GEARHEAD를 설치할 수 있습니다. 이 경우의 허용 TORQUE는 30 N·m / 300 kgf·cm 입니다.
- * 회전수는 MOTOR의 동기 회전수 (50 Hz : 1500 rpm, 60 Hz : 1800 rpm)를 기준으로 하여 감속비로 나누어서 계산하였습니다. 실제의 회전수는 부하의 크기에 따라서 표시된 수치보다 2~20% 적습니다.

CONNECTION DIAGRAMS

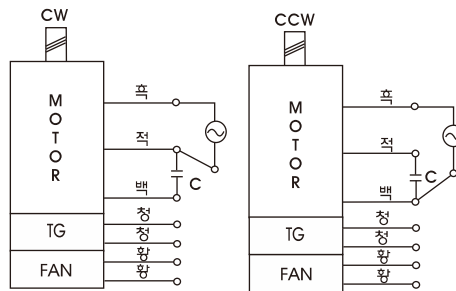

회전방향은 출력축에서 볼 경우

GEARHEAD

DIMENSIONS

K9P□B



K9P□BF, BUF

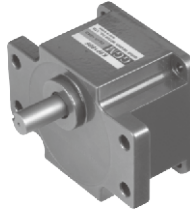

K9P□BU

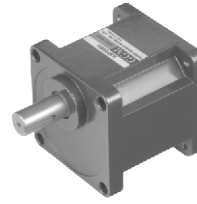

DECIMAL GEARHEAD

K9P10BX

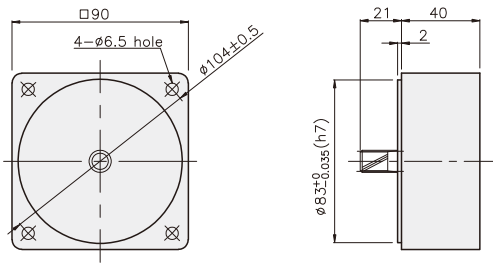

KEY SPEC

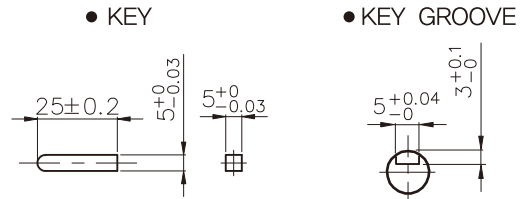

GEARHEAD

K9P□B

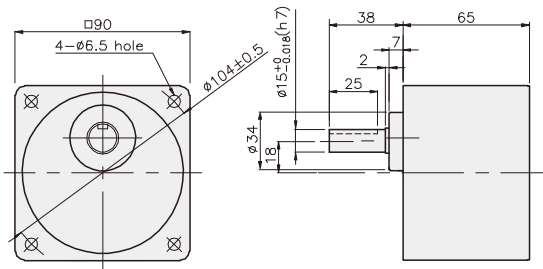

K9P□BF

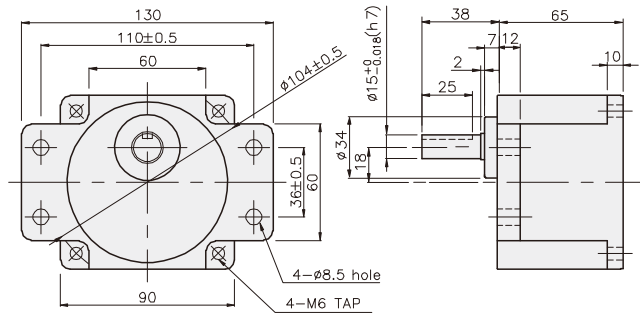

K9P□BU

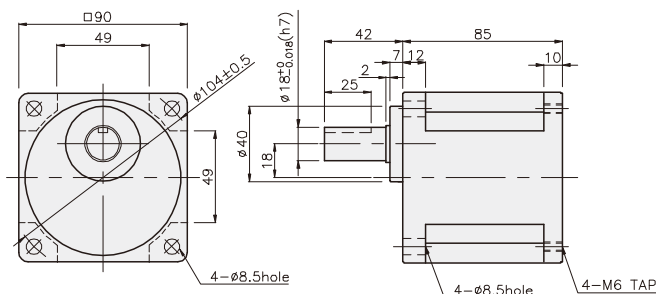

K9P□BUF

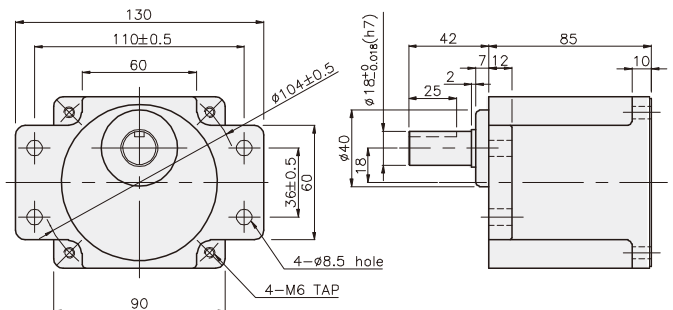

GEARHEAD

DIMENSIONS

K9RP90F□-SU + K9P□B

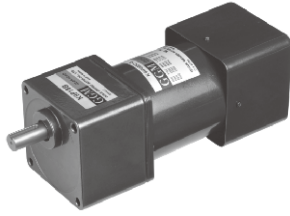

K9RP90F□-SU + K9P□BF, BUF

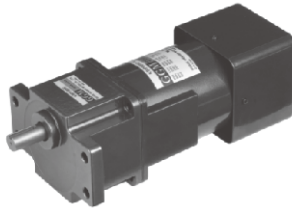

K9RP90F□-SU + K9P□BU

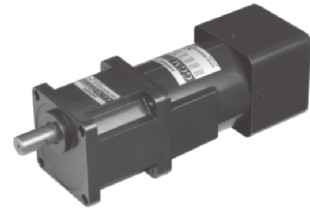

K9RP90F□-SU + K9P□B

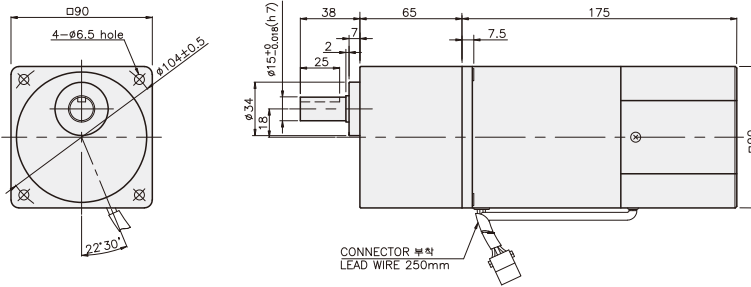

무게

PART	WEIGHT(kg)
MOTOR	3.06
DECIMAL GEARHEAD	0.62

치수도표

품번	적용기종	취부 BOLT
01	K9P3~200B	M6 P1.0 × 95
02	K9P10BX	M6 P1.0 × 140

무게

PART	WEIGHT(kg)
K9P3~10B	1.22
K9P12.5~20B	1.32
K9P25~60B	1.42
K9P75~200B	1.45

K9RP90F□-SU + K9P□BF

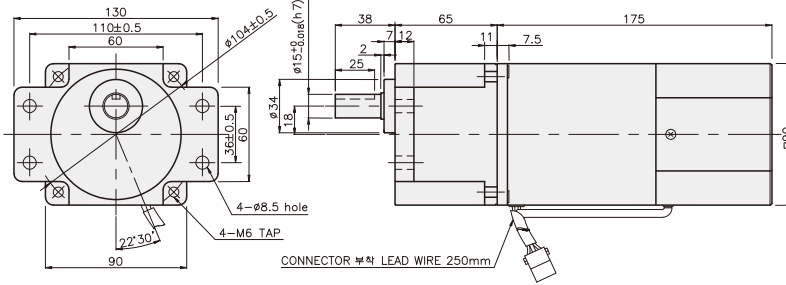

치수도표

품번	적용기종	취부 BOLT
01	K9P3~200BF	M6 P1.0 × 20
02	K9P10BX	M6 P1.0 × 65

무게

PART	WEIGHT(kg)
K9P3~10BF	1.22
K9P12.5~20BF	1.30
K9P25~60BF	1.42
K9P75~200BF	1.44

K9RP90F□-SU + K9P□BU

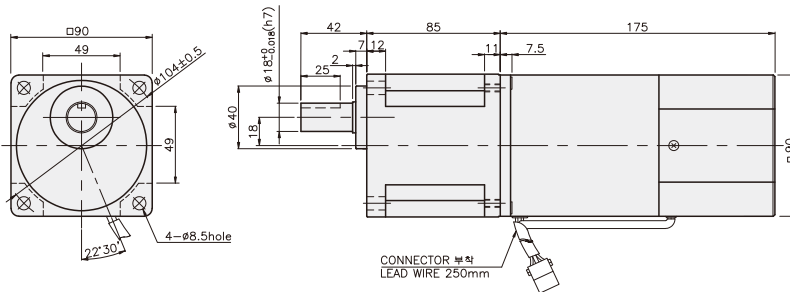

치수도표

품번	적용기종	취부 BOLT
01	K9P3~200BU	M6 P1.0 × 20
02	K9P10BX	M6 P1.0 × 65

무게

PART	WEIGHT(kg)
K9P3~10BU	1.44
K9P12.5~20BU	1.55
K9P25~60BU	1.69
K9P75~200BU	1.74

K9RP90F□-SU + K9P□BUF

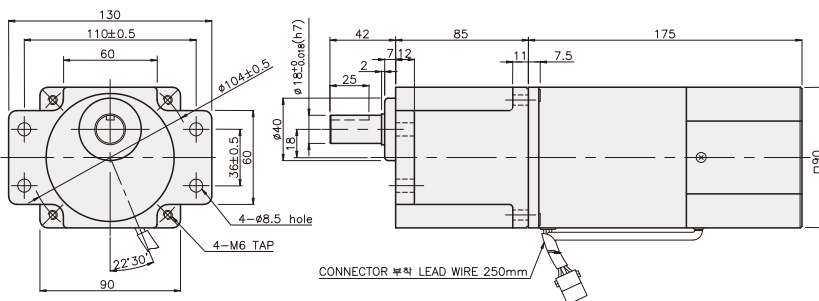

치수도표

품번	적용기종	취부 BOLT
01	K9P3~200BUF	M6 P1.0 × 20
02	K9P10BX	M6 P1.0 × 65

무게

PART	WEIGHT(kg)
K9P3~10BUF	1.50
K9P12.5~20BUF	1.62
K9P25~60BUF	1.76
K9P75~200BUF	1.82