

SPEED CONTROL & BRAKE MOTOR

60W

□90mm

K9RS60F□-D

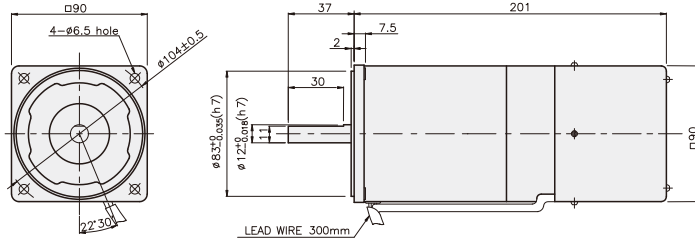

SPECIFICATIONS

60W 30分正格，4极

Model	Voltage (V)	Frequency (Hz)	Speed Range (rpm)	Permissible Torque		Start T. (N·m/kgf·cm)	Current (A)	Condenser (μF)	Friction T. (N·m/kgf·cm)
				1200 rpm (N·m/kgf·cm)	90 rpm (N·m/kgf·cm)				
K9R□60FJ-D	100	50	90 ~ 1400	0.5/5	0.17/1.7	0.3/3	2.5	25	1/10
		60	90 ~ 1700						
K9R□60FU-D	110	60	90 ~ 1700	0.5/5	0.17/1.7	0.295/2.95	2.1	17	1/10
	115						2.2		
K9R□60FL-D	200	50	90 ~ 1400	0.5/5	0.15/1.5	0.26/2.6	0.72	6	1/10
		60	90 ~ 1700	0.48/4.8	0.17/1.7	0.23/2.3	0.76		
K9R□60FC-D	220	50	90 ~ 1400	0.5/5	0.15/1.5	0.3/3	0.95	5	1/10
		60	90 ~ 1700	0.48/4.8	0.17/1.7	0.26/2.6	0.94		
	230	50	90 ~ 1400	0.5/5	0.15/1.5	0.3/3	1		
		60	90 ~ 1700	0.48/4.8	0.17/1.7	0.26/2.6	1.2		
K9R□60FD-D	240	50	90 ~ 1400	0.5/5	0.15/1.5	0.32/3.2	1.2	5	1/10

* □ : 电机轴形状 (S : STRAIGHT, P : PINION)

RATED TORQUE OF GEARHEAD

● 单项 100V/115V

单位 = 上段 : N·m / 下段 : kgf·cm

Model	Ratio	Speed(rpm)																							
		3	3.6	5	6	7.5	9	10	12.5	15	18	20	25	30	36	40	50	60	75	90	100	120	150	180	200
K9R□60F□-D	1200	1.22	1.46	2.03	2.43	3.04	3.65	4.05	4.56	5.47	6.56	7.29	8.20	9.84	11.81	13.12	16.40	19.68	20	20	20	20	20	20	20
	K9P□B, BF	90	0.41	0.50	0.69	0.83	1.03	1.24	1.38	1.55	1.86	2.23	2.48	2.79	3.35	4.02	4.46	5.58	6.69	7.53	9.03	10.04	12.05	15.06	18.07

● 单项 200V/240V

单位 = 上段 : N·m / 下段 : kgf·cm

Model	Ratio	Speed(rpm)																								
		3	3.6	5	6	7.5	9	10	12.5	15	18	20	25	30	36	40	50	60	75	90	100	120	150	180	200	
K9R□60F□-D	1200	200V/220V/230V/240V/50Hz	1.22	1.46	2.03	2.43	3.04	3.65	4.05	4.56	5.47	6.56	7.29	8.20	9.84	11.81	13.12	16.40	19.68	20	20	20	20	20	20	20
		200V/220V/230V/60Hz	1.17	1.40	1.94	2.33	2.92	3.50	3.89	4.37	5.25	6.30	7.00	7.87	9.45	11.34	12.60	15.75	18.90	20	20	20	20	20	20	20
	90	200V/220V/230V/50Hz	0.36	0.44	0.61	0.73	0.91	1.09	1.22	1.37	1.64	1.97	2.19	2.46	2.95	3.54	3.94	4.92	5.90	6.64	7.97	8.86	10.63	13.29	15.94	17.71
		200V/220V/230V/60Hz	0.41	0.50	0.69	0.83	1.03	1.24	1.38	1.55	1.86	2.23	2.48	2.79	3.35	4.02	4.46	5.58	6.69	7.53	9.03	10.04	12.05	15.06	18.07	20

* 减速机。中间减速机为另卖品。

* 减速机品名中 □里 为减速比。

* 色是与电机同一方向，其它为反方向。

* 表 比此减速比还要高的减速比时可以使用中间减速机。此时的许容扭矩为 20N·m/200kgf·cm。

* 转速以电机同期转速 (50Hz : 1500RPM 60Hz : 1800RPM) 为基准除以减速比计算出来的。实际转速根据负载的大小比表上的数据小2-20%。

GEARHEAD

CONNECTION DIAGRAMS

為保護觸點，請連接Cr電路以獲得電壓浪湧吸收，如接線圖所示。
 $R_o = 5 - 200\Omega$
 $C_o = 0.1 \sim 0.2\mu F \ 200WV(400WV)$

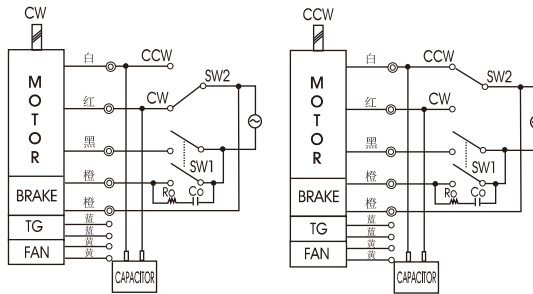

旋轉方向由出力軸側看時

DIMENSIONS

K9P□B



K9P□BF

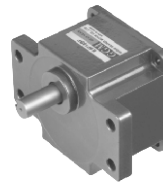

DECIMAL GEARHEAD

K9P10BX

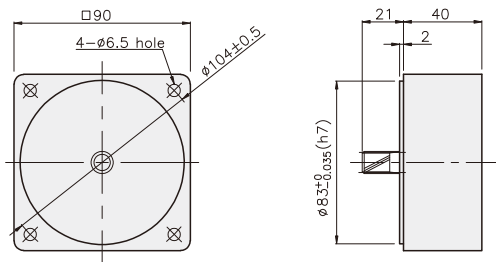

KEY SPEC

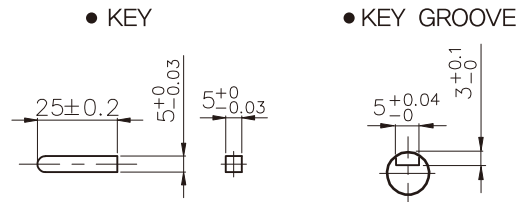

GEARHEAD

K9P□B

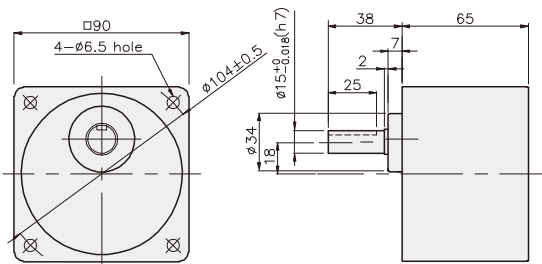

K9P□BF

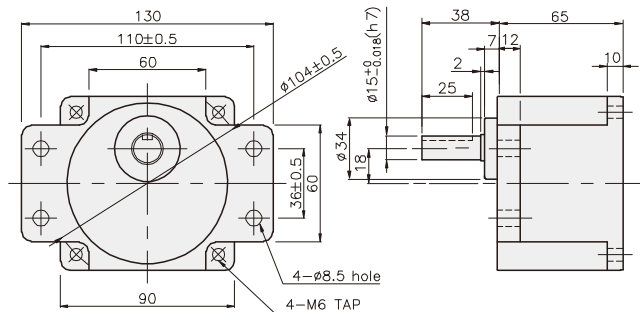

GEARHEAD

DIMENSIONS

K9RP60F□-D + K9P□B



K9RP60F□-D + K9P□BF



K9RP60F□-D + K9P□B

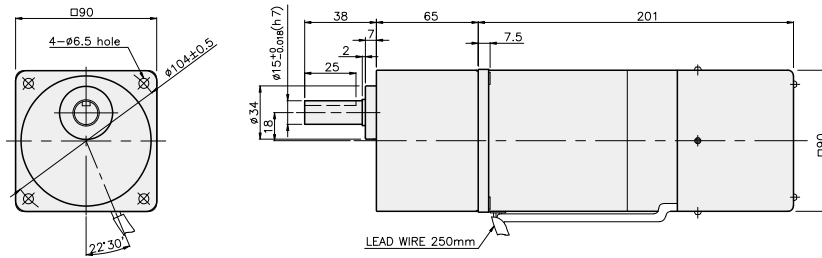

尺寸表

编号	应用型号	安装螺丝
01	K9P3~200B	M6 P1,0 X 95
02	K9P10BX	M6 P1,0 X 140

重量

PART	WEIGHT(kg)	
MOTOR	3,58	
DECIMAL GEAR HEAD	0,62	
GEAR HEAD	K9P3~10B	1,22
	K9P12,5~20B	1,32
	K9P25~60B	1,42
	K9P75~200B	1,45

K9RP60F□-D + K9P□BF

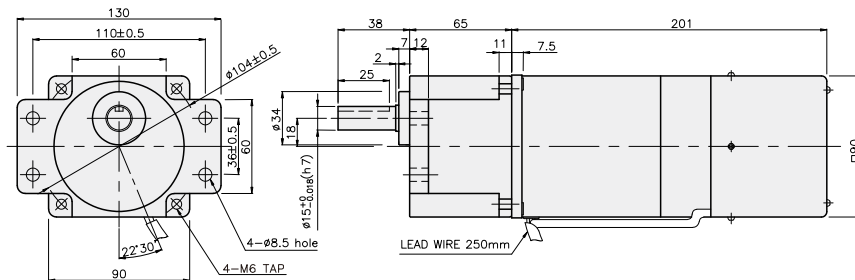

尺寸表

编号	应用型号	安装螺丝
01	K9P3~200BF	M6 P1,0 X 20
02	K9P10BX	M6 P1,0 X 65

重量

PART	WEIGHT(kg)	
MOTOR	3,58	
DECIMAL GEARHEAD	0,62	
GEAR HEAD	K9P3~10BF	1,22
	K9P12,5~20BF	1,30
	K9P25~60BF	1,42
	K9P75~200BF	1,44