

SPEED CONTROL MOTOR - SU SERIES

90W

□90mm

REVERSIBLE MOTOR

K9RS90F□-SU

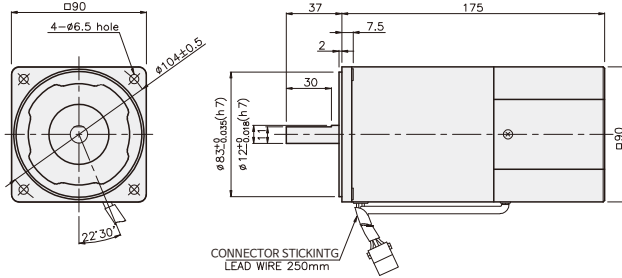

SPECIFICATIONS

90W 30分正格, 4极

Model	Voltage (V)	Frequency (Hz)	Speed (rpm)	Permissible Torque		Start T. (N·m/kgf·cm)	Current (A)	Condenser (μF)
				1200rpm (N·m/kgf·cm)	90rpm (N·m/kgf·cm)			
K9R□90FJ-SU	100	50	90 ~ 1400	0.25/2.5	0.4/4	3.6	35	
			90 ~ 1700					
K9R□90FU-SU	110	60	90 ~ 1700		0.38/3.8	3	25	
			115					
K9R□90FL-SU	200	50	90 ~ 1400		0.25/2.5	0.4/4	1.4	8
			90 ~ 1700					
K9R□90FC-SU	220	50	90 ~ 1400		0.25/2.5	0.43/4.3	1.2	7
			90 ~ 1700					
		60	90 ~ 1400					
			90 ~ 1700					
K9R□90FD-SU	240	50	90 ~ 1400		0.25/2.5	0.4/4	1.3	6

* □ : 电机轴形状 (S : STRAIGHT, P : PINION)

RATED TORQUE OF GEARHEAD

● 单项 100V/115V

单位 = 上段 : N·m / 下段 : kgf·cm

Model Motor/Gearhead	Ratio Speed(rpm)	3	3.6	5	6	7.5	9	10	12.5	15	18	20	25	30	36	40	50	60	75	90	100	120	150	180	200
		K9R□90F□-SU K9P□B, BF	1200	1.82 18.2	2.04 20.4	3.04 30.4	3.65 36.5	4.56 45.6	5.47 54.7	6.08 60.8	6.83 68.3	8.20 82.0	9.84 98.4	10.94 109.4	12.30 123.0	14.76 147.6	17.71 177.1	19.68 196.8	20	20	20	20	20	20	20
90	0.61 6.1		0.73 7.3	1.01 10.1	1.22 12.2	1.52 15.2	1.82 18.2	2.03 20.3	2.28 22.8	2.73 27.3	3.28 32.8	3.65 36.5	4.10 41.0	4.92 49.2	5.90 59.0	6.56 65.6	8.20 82.0	9.84 98.4	11.07 110.7	13.29 132.9	14.76 147.6	17.71 177.1	20	20	20

● 单项 200V/240V

单位 = 上段 : N·m / 下段 : kgf·cm

Model Motor/Gearhead	Ratio Speed(rpm)	3	3.6	5	6	7.5	9	10	12.5	15	18	20	25	30	36	40	50	60	75	90	100	120	150	180	200	
		K9R□90F□-SU K9P□B, BF	1200	1.82 18.2	2.19 21.9	3.04 30.4	3.65 36.5	4.56 45.6	5.47 54.7	6.08 60.8	6.83 68.3	8.20 82.0	9.84 98.4	10.94 109.4	12.30 123.0	14.76 147.6	17.71 177.1	19.68 196.8	20	20	20	20	20	20	20	20
90	200V/220V 230V/240V 50Hz		0.61 6.1	0.73 7.3	1.01 10.1	1.22 12.2	1.52 15.2	1.82 18.2	2.03 20.3	2.28 22.8	2.73 27.3	3.28 32.8	3.65 36.5	4.10 41.0	4.92 49.2	5.90 59.0	6.56 65.6	8.20 82.0	9.84 98.4	11.07 110.7	13.29 132.9	14.76 147.6	17.71 177.1	20	20	20
	200V/220V 230V/60Hz		0.68 6.8	0.82 8.2	1.13 11.3	1.36 13.6	1.70 17.0	2.04 20.4	2.27 22.7	2.55 25.5	3.06 30.6	3.67 36.7	4.08 40.8	4.59 45.9	5.51 55.1	6.61 66.1	7.35 73.5	9.19 91.9	11.02 110.2	12.40 124.0	14.88 148.8	16.53 165.3	19.84 198.4	20	20	20

- * 减速机。中间减速机为另卖品
- * 减速机品名中 □ 里 为减速比
- * 色是与电机同一方向，其它为反方向。
- * 表 比此减速比还要高的减速比时可以使用中间减速机。此时的许容扭矩为 20N·m/200kgf·cm。
- * 转速以电机同期转速 (50Hz : 1500RPM 60Hz : 1800RPM) 为基准除以减速比计算出来的。实际转速根据负载的大小比表上的数据小2~20%。

SPEED CONTROL MOTOR - SU SERIES

GEARHEAD

RATED TORQUE OF GEARHEAD

● 单项 100V/115V

单位 = 上段 : N·m / 下段 : kgf·cm

Model	Ratio	3	36	5	6	7.5	9	10	12.5	15	18	20	25	30	36	40	50	60	75	90	100	120	150	180	200
Motor/Gearhead	Speed(rpm)																								
K9R□90F□-SU K9P□BU, BUF	1200	1.82 18.2	2.19 21.9	3.04 30.4	3.65 36.5	4.56 45.6	5.47 54.7	6.08 60.8	6.83 68.3	8.20 82.0	9.84 98.4	10.94 109.4	12.30 123.0	14.76 147.6	17.71 177.1	19.68 196.8	24.60 246	29.52 295	30 300	30 300	30 300	30 300	30 300	30 300	30 300
	90	0.61 6.1	0.73 7.3	1.01 10.1	1.22 12.2	1.52 15.2	1.82 18.2	2.03 20.3	2.28 22.8	2.73 27.3	3.28 32.8	3.65 36.5	4.10 41.0	4.92 49.2	5.90 59.0	6.56 65.6	8.20 82.0	9.84 98.4	11.07 110.7	13.29 132.9	14.76 147.6	17.71 177.1	22.14 221.4	26.57 265.7	29.52 295.2

● 单项 200V/240V

单位 = 上段 : N·m / 下段 : kgf·cm

Model	Ratio	3	36	5	6	7.5	9	10	12.5	15	18	20	25	30	36	40	50	60	75	90	100	120	150	180	200	
Motor/Gearhead	Speed(rpm)																									
K9R□90F□-SU K9P□BU, BUF	1200	1.82 18.2	2.19 21.9	3.04 30.4	3.65 36.5	4.56 45.6	5.47 54.7	6.08 60.8	6.83 68.3	8.20 82.0	9.84 98.4	10.94 109.4	12.30 123.0	14.76 147.6	17.71 177.1	19.68 196.8	24.60 246	29.52 295	30 300	30 300	30 300	30 300	30 300	30 300	30 300	
	90	200V/220V 230V/240V 50Hz	0.61 6.1	0.73 7.3	1.01 10.1	1.22 12.2	1.52 15.2	1.82 18.2	2.03 20.3	2.28 22.8	2.73 27.3	3.28 32.8	3.65 36.5	4.10 41.0	4.92 49.2	5.90 59.0	6.56 65.6	8.20 82.0	9.84 98.4	11.07 110.7	13.29 132.9	14.76 147.6	17.71 177.1	22.14 221.4	26.57 265.7	29.52 295.2
		200V/220V 230V/60Hz	0.68 6.8	0.82 8.2	1.13 11.3	1.36 13.6	1.70 17.0	2.04 20.4	2.27 22.7	2.55 25.5	3.06 30.6	3.67 36.7	4.08 40.8	4.59 45.9	5.51 55.1	6.61 66.1	7.35 73.5	9.19 91.9	11.02 110.2	12.40 124.0	14.88 148.8	16.53 165.3	19.84 198.4	24.80 248.0	29.76 297.6	30 300

- * 减速机。中间减速机为另卖品
- * 减速机品名中 □ 里 为减速比
- * ■ 色是与电机同一方向，其它为反方向。
- * 表 比此减速比还要高的减速比时可以使用中间减速机。此时的许容扭矩为 30N·m/300kgf·cm。
- * 转速以电机同期转速（50Hz：1500RPM 60Hz：1800RPM）为基准除以减速比计算出来的。实际转速根据负载的大小比表上的数据小2-20%。

CONNECTION DIAGRAMS

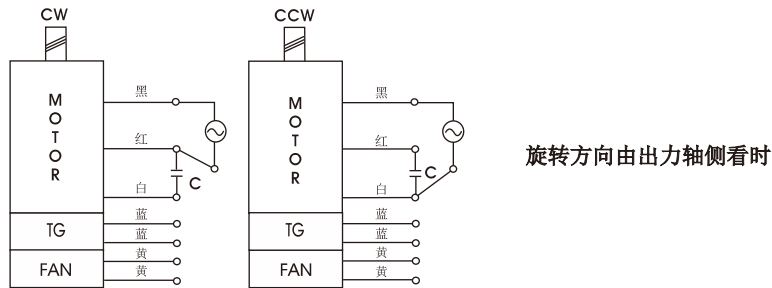

GEARHEAD

DIMENSIONS

K9P□B



K9P□BF, BUF

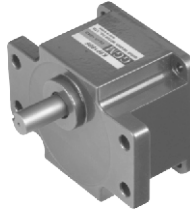

K9P□BU

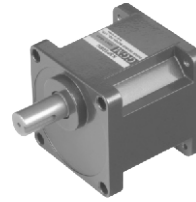

DECIMAL GEARHEAD

K9P10BX

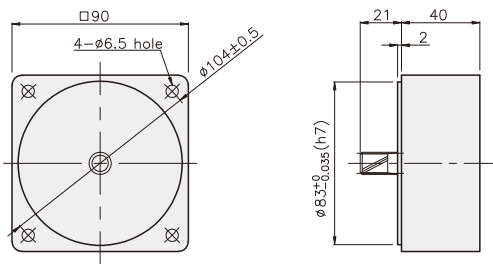

KEY SPEC

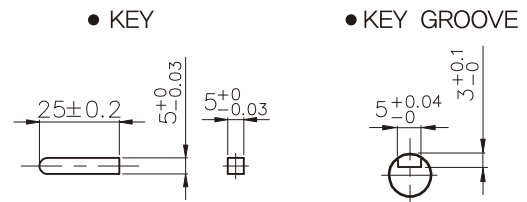

GEARHEAD

K9P□B

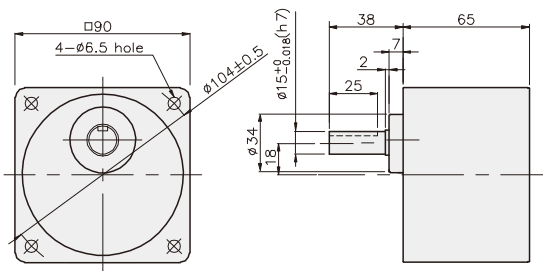

K9P□BF

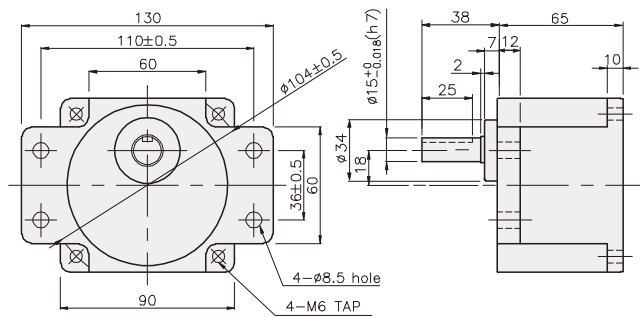

K9P□BU

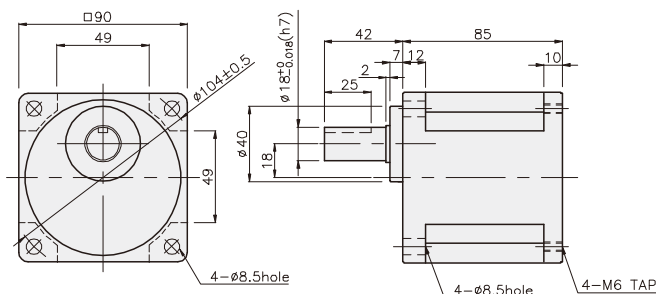

K9P□BUF

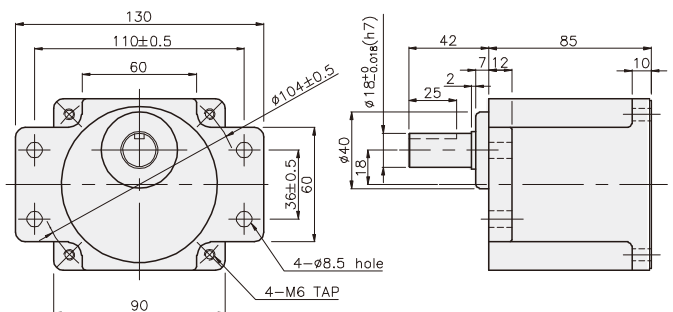

GEARHEAD

DIMENSIONS

K9RP90F□-SU + K9P□B



K9RP90F□-SU + K9P□BF, BUF



K9RP90F□-SU + K9P□BU



K9RP90F□-SU + K9P□B

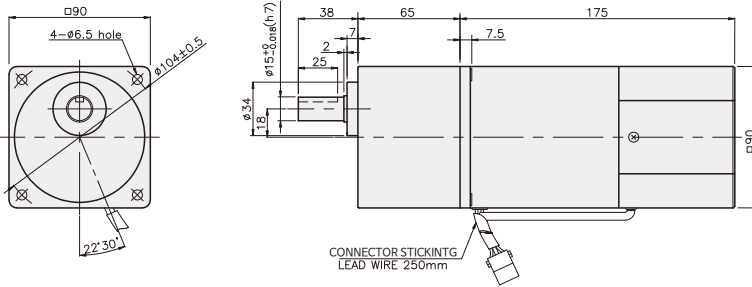

重量

PART	WEIGHT(kg)
MOTOR	3,06
DECIMAL GEAR HEAD	0,62

尺寸表

编号	应用型号	安装螺丝
01	K9P3~200B	M6 P1,0 X 95
02	K9P10BX	M6 P1,0 X 140

重量

PART	WEIGHT(kg)
K9P3~10B	1,22
K9P12,5~20B	1,32
K9P25~60B	1,42
K9P75~200B	1,45

尺寸表

编号	应用型号	安装螺丝
01	K9P3~200BF	M6 P1,0 X 20
02	K9P10BX	M6 P1,0 X 65

重量

PART	WEIGHT(kg)
K9P3~10BF	1,22
K9P12,5~20BF	1,30
K9P25~60BF	1,42
K9P75~200BF	1,44

K9RP90F□-SU + K9P□BF

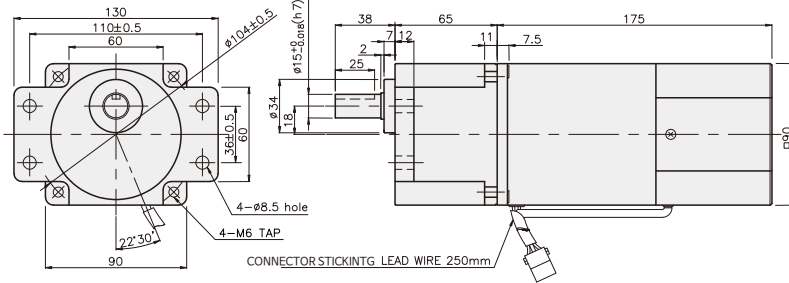

K9RP90F□-SU + K9P□BU

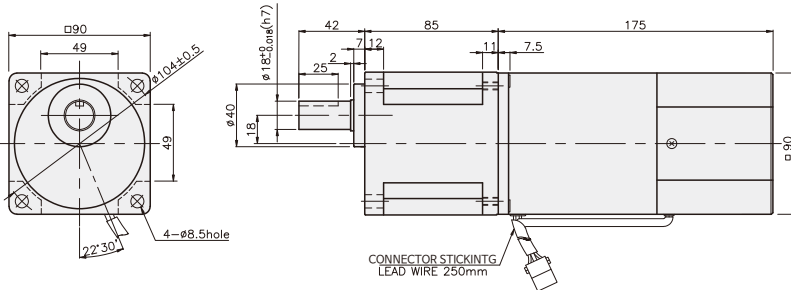

尺寸表

编号	应用型号	安装螺丝
01	K9P3~200BU	M6 P1,0 X 20
02	K9P10BX	M6 P1,0 X 65

重量

PART	WEIGHT(kg)
K9P3~10BU	1,44
K9P12,5~20BU	1,55
K9P25~60BU	1,69
K9P75~200BU	1,74

K9RP90F□-SU + K9P□BUF

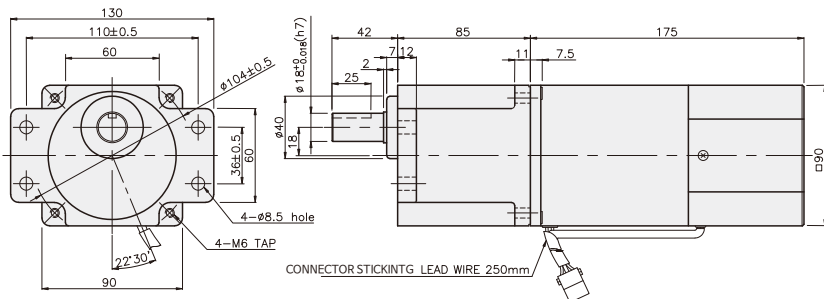

尺寸表

编号	应用型号	安装螺丝
01	K9P3~200BUF	M6 P1,0 X 20
02	K9P10BX	M6 P1,0 X 65

重量

PART	WEIGHT(kg)
K9P3~10BUF	1,50
K9P12,5~20BUF	1,62
K9P25~60BUF	1,76
K9P75~200BUF	1,82