

GEARHEAD

RATED TORQUE OF GEARHEAD

● 单项 200V/240V

单位 = 上段 : N·m / 下段 : kgf·cm

Model		Ratio																								
Motor/Gearhead	Speed(rpm)	3	3.6	5	6	7.5	9	10	12.5	15	18	20	25	30	36	40	50	60	75	90	100	120	150	180	200	
K9R□180F□-SU K9R□BU, BUF	1200	200V/220V 50Hz/60Hz	2.14	2.57	3.56	4.28	5.35	6.42	7.13	8.02	9.62	11.55	12.83	14.43	17.32	20.79	23.09	28.87	30	30	30	30	30	30	30	30
		230V 50Hz/60Hz 240V/50Hz	2.31	2.77	3.85	4.62	5.77	6.93	7.70	8.66	10.39	12.47	13.85	15.58	18.70	22.44	24.93	30	30	30	30	30	30	20	30	30
	90	200V/220V 50Hz/60Hz	0.73	0.87	1.22	1.46	1.82	2.19	2.43	2.73	3.28	3.94	4.37	4.92	5.90	7.09	7.87	9.84	11.81	13.29	15.94	17.71	21.26	26.57	30	30
		230V 50Hz/60Hz 240V/50Hz	0.78	0.93	1.30	1.56	1.94	2.33	2.59	2.92	3.50	4.20	4.67	5.25	6.30	7.56	8.40	10.50	12.60	14.17	17.01	18.90	22.67	28.34	30	30

● 单项 100V/115V

单位 = 上段 : N·m / 下段 : kgf·cm

Model		Ratio																								
Motor/Gearhead	Speed(rpm)	3	3.6	5	6	7.5	9	10	12.5	15	18	20	25	30	36	40	50	60	75	90	100	120	150	180	200	
K9R□180F□-DK9R□BU	1200	100V 50/60Hz	2.14	2.57	3.56	4.28	5.35	6.42	7.13	8.02	9.62	11.55	12.83	14.43	17.32	20.79	23.09	28.87	30	30	30	30	30	30	30	30
		110V/115V 60Hz	2.67	3.21	4.46	5.35	6.68	8.02	8.91	10.02	12.03	14.43	16.04	18.04	21.65	25.98	28.87	30	30	30	30	30	30	30	30	30
	90	100V 50/60Hz	0.80	0.96	1.34	1.60	2.00	2.41	2.67	3.01	3.61	4.33	4.81	5.41	6.50	7.79	8.66	10.83	12.99	14.61	17.54	19.49	23.38	29.23	30	30
		110V/115V 60Hz	0.92	1.11	1.54	1.85	2.31	2.77	3.08	3.46	4.16	4.99	5.54	6.23	7.48	8.98	9.97	12.47	14.96	16.83	20.19	22.44	26.93	30	30	30

● 单项 200V/240V

单位 = 上段 : N·m / 下段 : kgf·cm

Model		Ratio																								
Motor/Gearhead	Speed(rpm)	3	3.6	5	6	7.5	9	10	12.5	15	18	20	25	30	36	40	50	60	75	90	100	120	150	180	200	
K9R□180F□-DK9R□BU	1200	200V/220V 50Hz/60Hz	2.14	2.57	3.56	4.28	5.35	6.42	7.13	8.02	9.62	11.55	12.83	14.43	17.32	20.79	23.09	28.87	30	30	30	30	30	30	30	30
		230V 50Hz/60Hz 240V/50Hz	2.31	2.77	3.85	4.62	5.77	6.93	7.70	8.66	10.39	12.47	13.85	15.58	18.70	22.44	24.93	30	30	30	30	30	30	30	30	30
	90	200V/220V 50Hz/60Hz	0.73	0.87	1.22	1.46	1.82	2.19	2.43	2.73	3.28	3.94	4.37	4.92	5.90	7.09	7.87	9.84	11.81	13.29	15.94	17.71	21.26	26.57	30	30
		230V 50Hz/60Hz 240V/50Hz	0.78	0.93	1.30	1.56	1.94	2.33	2.59	2.92	3.50	4.20	4.67	5.25	6.30	7.56	8.40	10.50	12.60	14.17	17.01	18.90	22.67	28.34	30	30

● 单项 100V/115V

单位 = 上段 : N·m / 下段 : kgf·cm

Model		Ratio																								
Motor/Gearhead	Speed(rpm)	3	3.6	5	6	7.5	9	10	12.5	15	18	20	25	30	36	40	50	60	75	90	100	120	150	180	200	
K9R□180F□-DK9R□BUF	1200	100V 50/60Hz	2.14	2.57	3.56	4.28	5.35	6.42	7.13	8.02	9.62	11.55	12.83	14.43	17.32	20.79	23.09	28.87	30	30	30	30	30	30	30	30
		110V/115V 60Hz	2.67	3.21	4.46	5.35	6.68	8.02	8.91	10.02	12.03	14.43	16.04	18.04	21.65	25.98	28.87	30	30	30	30	30	30	30	30	30
	90	100V 50/60Hz	0.80	0.96	1.34	1.60	2.00	2.41	2.67	3.01	3.61	4.33	4.81	5.41	6.50	7.79	8.66	10.83	12.99	14.61	17.54	19.49	23.38	29.23	30	30
		110V/115V 60Hz	0.92	1.11	1.54	1.85	2.31	2.77	3.08	3.46	4.16	4.99	5.54	6.23	7.48	8.98	9.97	12.47	14.96	16.83	20.19	22.44	26.93	30	30	30

● 单项 200V/240V

单位 = 上段 : N·m / 下段 : kgf·cm

Model		Ratio																								
Motor/Gearhead	Speed(rpm)	3	3.6	5	6	7.5	9	10	12.5	15	18	20	25	30	36	40	50	60	75	90	100	120	150	180	200	
K9R□180F□-DK9R□BUF	1200	200V/220V 50Hz/60Hz	2.14	2.57	3.56	4.28	5.35	6.42	7.13	8.02	9.62	11.55	12.83	14.43	17.32	20.79	23.09	28.87	30	30	30	30	30	30	30	30
		230V 50Hz/60Hz 240V/50Hz	2.31	2.77	3.85	4.62	5.77	6.93	7.70	8.66	10.39	12.47	13.85	15.58	18.70	22.44	24.93	30	30	30	30	30	30	30	30	30
	90	200V/220V 50Hz/60Hz	0.73	0.87	1.22	1.46	1.82	2.19	2.43	2.73	3.28	3.94	4.37	4.92	5.90	7.09	7.87	9.84	11.81	13.29	15.94	17.71	21.26	26.57	30	30
		230V 50Hz/60Hz 240V/50Hz	0.78	0.93	1.30	1.56	1.94	2.33	2.59	2.92	3.50	4.20	4.67	5.25	6.30	7.56	8.40	10.50	12.60	14.17	17.01	18.90	22.67	28.34	30	30

* 减速机。中间减速机为另卖品

* 减速机品名中 □ 里 为减速比

* 色是与电机同一方向，其它为反方向。

* 表 比此减速比还要高的减速比时可以使用中间减速机。此时的许容扭矩为 30N·m/300kgf·cm。

* 转速以电机同期转速（50Hz：1500RPM 60Hz：1800RPM）为基准除以减速比计算出来的。实际转速根据负载的大小比表上的数据小2~20%。

GEARHEAD

CONNECTION DIAGRAMS

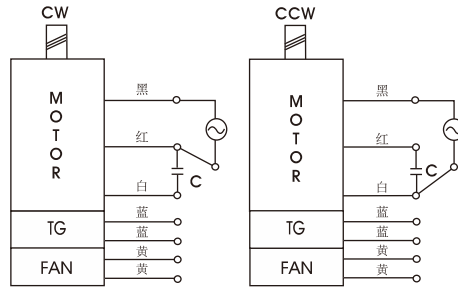

旋转方向由出力轴侧看时

DIMENSIONS

K9P□BU



K9P□BUF



DECIMAL GEARHEAD

K9P10BX

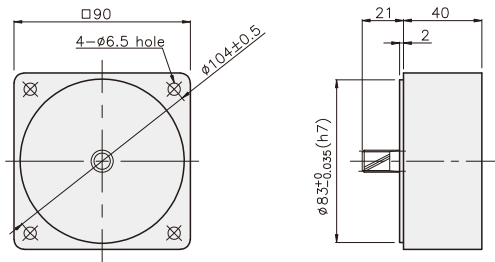

KEY SPEC

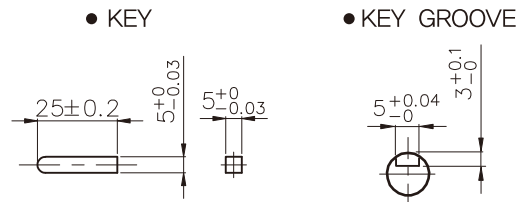

GEARHEAD

K9P□BU

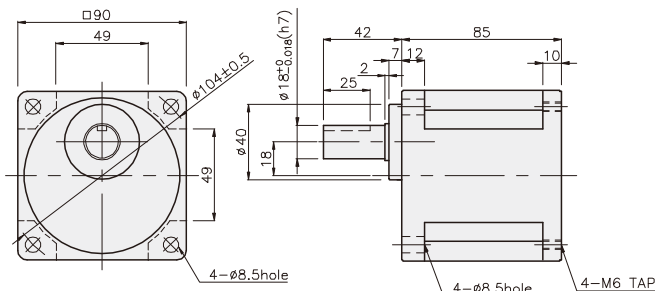

K9P□BUF

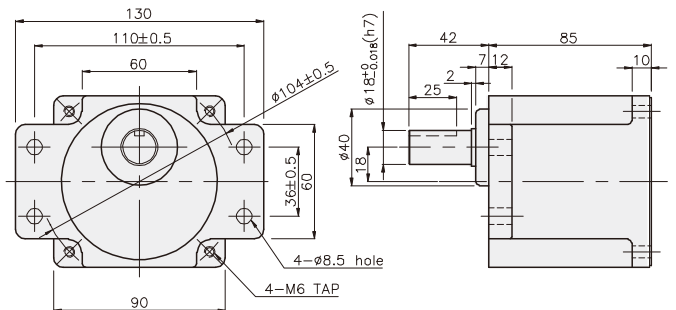

SPEED CONTROL MOTOR
- SU SERIES

GEARHEAD

DIMENSIONS

K9RP180F□-SU + K9P□BU

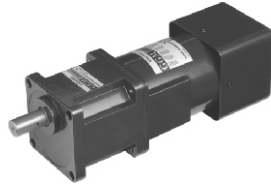

K9RP180F□-SU + K9P□BUF

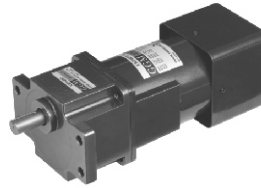

重量

PART	WEIGHT(kg)
MOTOR	4.24
DECIMAL GEAR HEAD	0.62

尺寸表

编号	应用型号	安装螺丝
01	K9P3~200BU	M6 P1.0 X 20
02	K9P10BX	M6 P1.0 X 65

重量

PART	WEIGHT(kg)
K9P3~10BU	1.44
K9P12.5~20BU	1.55
K9P25~60BU	1.69
K9P75~200BU	1.74

尺寸表

编号	应用型号	安装螺丝
01	K9P3~200BUF	M6 P1.0 X 20
02	K9P10BX	M6 P1.0 X 65

重量

PART	WEIGHT(kg)
K9P3~10BUF	1.50
K9P12.5~20BUF	1.62
K9P25~60BUF	1.76
K9P75~200BUF	1.82

K9RP180F□-SU + K9P□BU

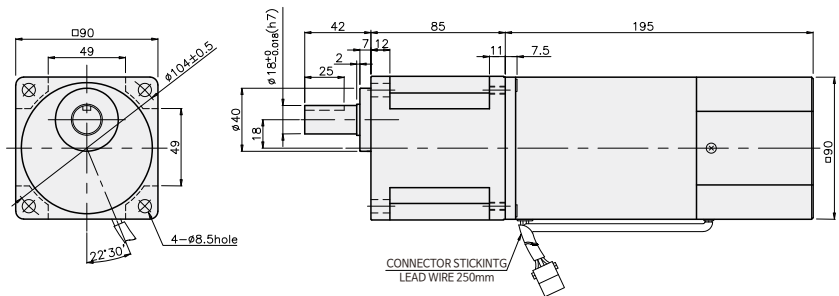

K9RP180F□-SU + K9P□BUF

