

SPEED CONTROL MOTOR – SP SERIES

60W

□90mm INDUCTION MOTOR

K9IS60F□-SP

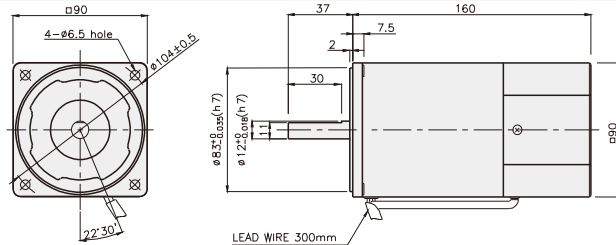

SPECIFICATIONS

60W 连续正格，4极

Model	Voltage (V)	Frequency (Hz)	Speed (rpm)	Permissible Torque		Start T. (N·m/kgf·cm)	Current (A)	Condenser (µF)
				1200 rpm (N·m/kgf·cm)	90 rpm (N·m/kgf·cm)			
K9I□60FJ-SP	100	50	90 ~ 1400	0.45/4.5	0.15/1.5	0.24/2.4	2.3	20
		60	90 ~ 1700			0.21/2.1		
K9I□60FU-SP	110	60	90 ~ 1700	0.45/4.5	0.15/1.5	0.285/2.85	2	16
	115					2.1		
K9I□60FL-SP	200	50	90 ~ 1400	0.49/4.9	0.14/1.4	0.24/2.4	1.2	5
		60	90 ~ 1700	0.45/4.5	0.16/1.6	0.21/2.1		
K9I□60FC-SP	220	50	90 ~ 1400	0.49/4.9	0.14/1.4	0.24/2.4	0.91	4
		60	90 ~ 1700	0.45/4.5	0.16/1.6	0.21/2.1		
	230	50	90 ~ 1400	0.49/4.9	0.14/1.4	0.24/2.4	1	
		60	90 ~ 1700	0.45/4.5	0.16/1.6	0.24/2.4		
K9I□60FD-SP	240	50	90 ~ 1400	0.49/4.9	0.14/1.4	0.28/2.8	1.1	4

* □: 电机轴形状 (S: STRAIGHT, P: PINION) * 型号名称末尾的 60FC-SU 部件号是 UL 标准认证产品。UL FILE NO. E204632

RATED TORQUE OF GEARHEAD

● 单项 100V/115V

单位: 上段: N·m / 下段: kgf·cm

Model	Ratio	Speed(rpm)																							
		3	3.6	5	6	7.5	9	10	12.5	15	18	20	25	30	36	40	50	60	75	90	100	120	150	180	200
K9I□60F□-SP K9P□B, BF	1200	1.09 10.9	1.31 13.1	1.82 18.2	2.19 21.9	2.73 27.3	3.28 32.8	3.65 36.5	4.10 41.0	4.92 49.2	5.90 59.0	6.56 65.6	7.38 73.8	8.86 88.6	10.63 106.3	11.81 118.1	14.76 147.6	17.71 177.1	20 200	20 200	20 200	20 200	20 200	20 200	20 200
	90	0.36 3.6	0.44 4.4	0.61 6.1	0.73 7.3	0.91 9.1	1.09 10.9	1.22 12.2	1.37 13.7	1.64 16.4	1.97 19.7	2.19 21.9	2.46 24.6	2.95 29.5	3.54 35.4	3.94 39.4	4.92 49.2	5.90 59.0	6.64 66.4	7.97 79.7	8.86 88.6	10.63 106.3	13.29 132.9	15.94 159.4	17.71 177.1

● 单项 200V/240V

单位: 上段: N·m / 下段: kgf·cm

Model	Ratio	Speed(rpm)																								
		3	3.6	5	6	7.5	9	10	12.5	15	18	20	25	30	36	40	50	60	75	90	100	120	150	180	200	
K9I□60F□-SP K9P□B, BF	1200	200V/220V/230V/240V/50Hz	1.19 11.9	1.43 14.3	1.98 19.8	2.38 23.8	2.98 29.8	3.57 35.7	3.97 39.7	4.47 44.7	5.36 53.6	6.43 64.3	7.14 71.4	8.04 80.4	9.64 96.4	11.57 115.7	12.86 128.6	16.07 160.7	19.29 192.9	20 200	20 200	20 200	20 200	20 200	20 200	20 200
		200V/220V/230V/60Hz	1.09 10.9	1.31 13.1	1.82 18.2	2.19 21.9	2.73 27.3	3.28 32.8	3.65 36.5	4.10 41.0	4.92 49.2	5.90 59.0	6.56 65.6	7.38 73.8	8.86 88.6	10.63 106.3	11.81 118.1	14.76 147.6	17.71 177.1	20 200	20 200	20 200	20 200	20 200	20 200	20 200
	90	200V/220V/230V/50Hz	0.34 3.4	0.41 4.1	0.57 5.7	0.68 6.8	0.85 8.5	1.02 10.2	1.13 11.3	1.28 12.8	1.53 15.3	1.84 18.4	2.04 20.4	2.30 23.0	2.76 27.6	3.31 33.1	3.67 36.7	4.59 45.9	5.51 55.1	6.20 62.0	7.44 74.4	8.27 82.7	9.92 99.2	12.40 124.0	14.88 148.8	16.53 165.3
		200V/220V/230V/60Hz	0.39 3.9	0.47 4.7	0.65 6.5	0.78 7.8	0.97 9.7	1.17 11.7	1.30 13.0	1.46 14.6	1.75 17.5	2.10 21.0	2.33 23.3	2.62 26.2	3.15 31.5	3.78 37.8	4.20 42.0	5.25 52.5	6.30 63.0	7.09 70.9	8.50 85.0	9.45 94.5	11.34 113.4	14.17 141.7	17.01 170.1	18.90 189.0

- * 减速机。中间减速机为另卖品。
- * 减速机品名中 □ 里为减速比。
- * 色是与电机同一方向，其它为反方向。
- * 表 比此减速比还要高的减速比时可以使用中间减速机。此时的许容扭矩为 20N·m/200kgf·cm。
- * 转速以电机同期转速 (50Hz: 1500RPM 60Hz: 1800RPM) 为基准除以减速比计算出来的。实际转速根据负载的大小比表上的数据小2~20%。

GEARHEAD

CONNECTION DIAGRAMS

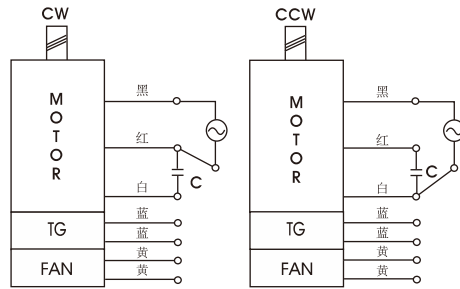

旋转方向由出力轴侧看时

DIMENSIONS

K9P□B



K9P□BF



DECIMAL GEARHEAD

K9P10BX

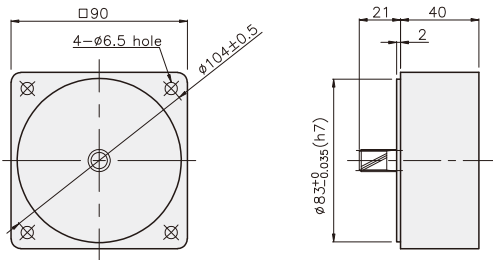

KEY SPEC

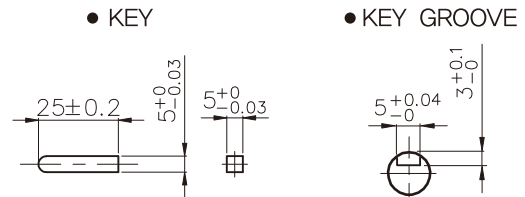

GEARHEAD

K9P□B

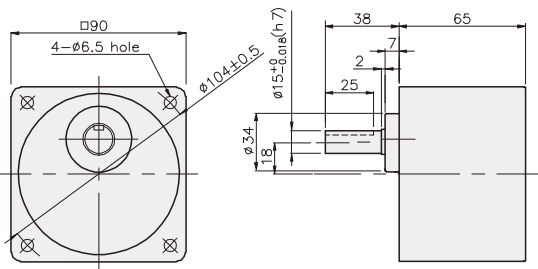

K9P□BF

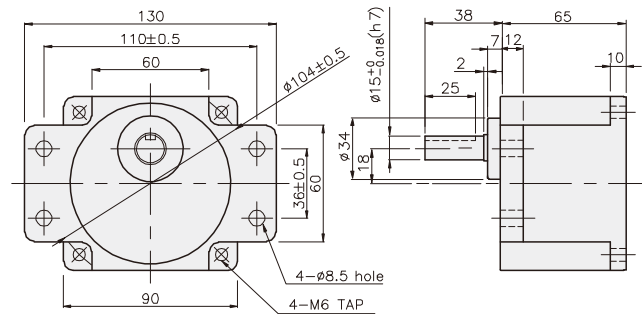

GEARHEAD

DIMENSIONS

K9IP60F□-SP + K9P□B



K9IP60F□-SP + K9P□BF



K9IP60F□-SP + K9P□B

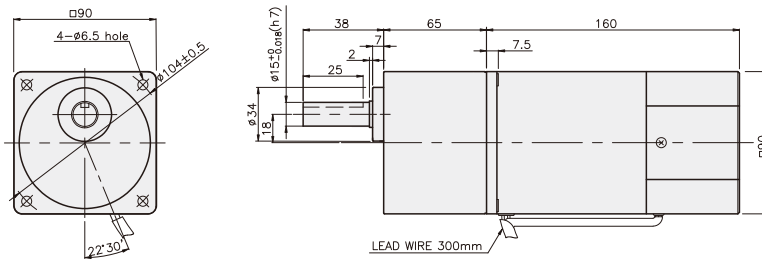

尺寸表

编号	应用型号	安装螺丝
01	K9P3~200B	M6 P1.0 X 95
02	K9P10BX	M6 P1.0 X 140

重量

PART	WEIGHT(kg)	
MOTOR	3.06	
DECIMAL GEAR HEAD	0.62	
GEAR HEAD	K9P3~10B	1.22
	K9P12.5~20B	1.32
	K9P25~60B	1.42
	K9P75~200B	1.45

K9IP60F□-SP + K9P□BF

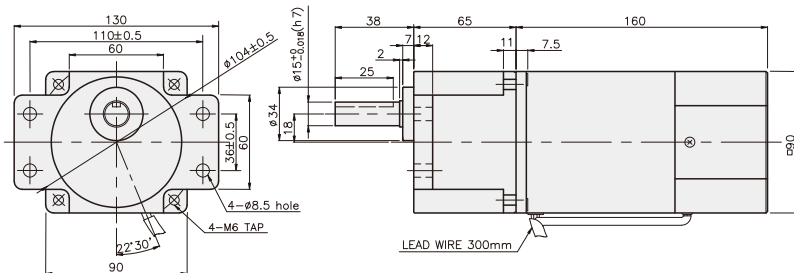

尺寸表

编号	应用型号	安装螺丝
01	K9P3~200BF	M6 P1.0 X 20
02	K9P10BX	M6 P1.0 X 65

重量

PART	WEIGHT(kg)	
MOTOR	3.06	
DECIMAL GEAR HEAD	0.62	
GEAR HEAD	K9P3~10BF	1.22
	K9P12.5~20BF	1.30
	K9P25~60BF	1.42
	K9P75~200BF	1.44